



INNOVATIVE  
IRRIGATION

**komet** | *Pivot*

**Pivot Sprinkler Products**

for Mechanized Irrigation Systems

**Aspersores para Pivot**

para sistemas mecanizados de riego

**THE KOMET ADVANTAGE:**  
INNOVATION WITH IMPACT

The quality of a product is a direct reflection of the principles of the people who design, manufacture and market it. When developing new products, we at Komet must make sure that they live up to the values in which we strongly believe: quality, reliability and a solid advantage to the customer. These are the core values that all Komet products are built upon. By combining highly engineered materials and the strictest quality controls, we manufacture reliability into every product we make. Add to that the industry exclusive innovative features implemented into all of our products, and the advantages to our customers are obvious. The Komet Pivot Sprinkler Products represent the pinnacle of quality, innovative technology, performance and reliability.

Un nuevo producto refleja siempre también las personas que participaron en el proceso de su desarrollo y producción. También refleja las convicciones que éstas personas asumen. Para nosotros estas convicciones son valores como alta calidad, gran fiabilidad y una inmanente ventaja para el usuario. Esta exigencia representa un compromiso serio para nosotros. Creemos en lo que hacemos, y sobre todo, en cómo lo hacemos. Cumplimos con esta exigencia, empleando materiales de óptima calidad. Ingeniería innovadora influye en la concepción y en los ensayos de nuevos productos. La producción finalmente, es acompañada de frecuentes controles de calidad, asegurando así la solidez y longevidad de nuestros productos. Los productos Komet Pivot Aspersores son el resultado de esta perfecta combinación de tecnología innovadora, rendimiento y fiabilidad.

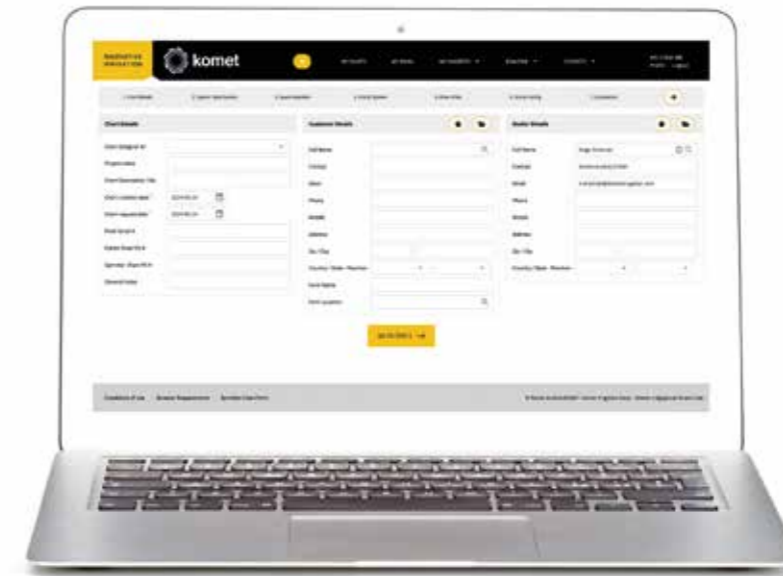

## Komet RainLogic Software

The RainLogic Software with the most advanced calculation logic and sprinkler chart options. El RainLogic Software con la más avanzada lógica de cálculo y opciones de cartas de aspersores.

### Komet Rapid Fit Nozzle System



### Truss Rod Clip (TRC)



### Komet Precision Regulator (KPR-X)

Complete line of All-Flow Pressure Regulators  
Línea completa de All-Flow reguladores de presión



### Komet Precision Spray (KPS)

Complete line of LESA/LEPA sprinkler devices  
Línea completa de dispositivos LESA/LEPA



### Komet Precision Twister (KPT)

Complete line of distribution devices for installation on drops and on top of pipe  
Línea completa de dispositivos de distribución para uso en bajante y encima del tubo



### Komet Precision Wave (KPW)

Unique End-of-System Sprinkler  
Aspersor único de final de sistema





**Optimal performance in various applications /  
Óptimo rendimiento en varias aplicaciones**

Pivot

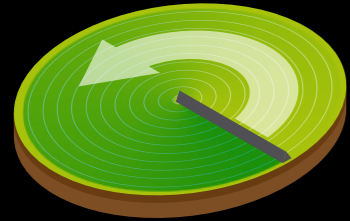

Linear

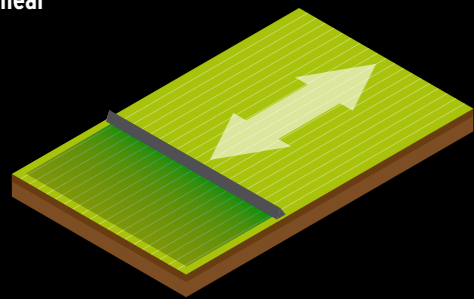

Pivoting Linear

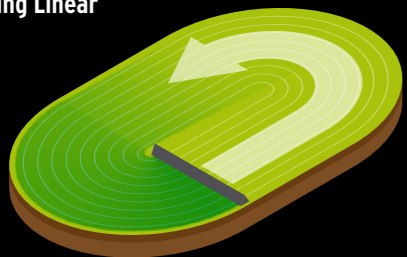

Sugar cane / Caña de azúcar - 6psi - KPT Standard Trajectory Angle



Carrots / Zanahorias - 15psi - KPT Standard Trajectory Angle



Soybeans / Habas de soja - 10psi - KPT Standard Trajectory Angle



Turf / Césped - 10psi - KPT Standard Trajectory Angle



Black beans / Frijoles - 10psi - KPT Ultra-Low Trajectory Angle



Corn in canopy / Dosel de maíz - 10psi - KPT Standard Trajectory Angle







## Komet Philosophy

We are a family business. We inherited the values that are the foundation of our relationships from the company's founder Roland Drechsel, our father. For us, the order of the day is honesty, respect and trust. We believe that in today's world, rather than inventing new promises, it is far more important to respect, uphold and build on the customer promises that our company was founded on. In addition to providing the highest quality irrigation equipment, we want to make sure our customers have water application products that operate at the highest levels of efficiency and effectiveness, which in turn will help to limit the waste of our natural resources. We believe in building long lasting relationships with our customers. This gives us the opportunity to understand their needs, analyze how our products are meeting those needs, and to continue to improve. We believe in what we do, and are passionate about how we do it.

## Komet Filosofía

Somos una empresa familiar. Y como tal, nos sentimos comprometidos con los valores y la tradición adoptados ya por el fundador de la empresa Roland Drechsel, nuestro padre. Honestidad, respeto y confianza figuran para nosotros en primer lugar, ya que estos valores en tiempos del comercio globalizado, constituyen la base del éxito de relaciones comerciales. El cumplir con una promesa dada, ver un acuerdo como obligación, nos parece ser hoy en día más importante que nunca antes. Como partner competente y fiable, ayudamos a nuestros clientes a lograr un excelente riego por aspersión, reuniendo óptima efectividad y el máximo cuidado de recursos. Nos esforzamos en establecer relaciones comerciales durables y sólidas con nuestros clientes. Un estrecho contacto y el exacto análisis de las circunstancias y experiencias de cada uno, nos dan la posibilidad de ofrecer soluciones individuales y, donde sea necesario, optimizar conceptos. Un gran número de relaciones comerciales, mantenidas desde hace años, nos confirma, que es éste el camino correcto.





## Operating Cost

VS

## Purchase Cost

A trend has been developing in the past few years in which the purchase cost of a product has become the most important factor when purchasing equipment. This trend has changed the scope of many companies, moving to a short term market approach that focuses on the purchase cost instead of its real operating cost. We at Komet are firmly convinced that our customers generate greater benefit by optimizing the operating cost of the products they use. Our priorities when developing products are to make sure that they are the most reliable, always operate at the optimum efficiency, are easy to use and minimize the waste of precious natural resources. It is surely less demanding and more economically feasible to concentrate a company's product lines with the short term market approach, but we believe that the credibility of our brand is based on the long term quality and performance of our products, and more importantly the return on investment our customers can realize.

## Costos Operativos

VS

## Costos de Inversión

Una de las leyes del mercado de los años recientes, es priorizar los costos de adquisición de un producto. Esto es comprensible, pero dificulta en muchos casos un análisis eficaz de la relación entre costos y beneficios. Especialmente en productos como los nuestros, de larga durabilidad y en uso durante muchos años, los principales factores para determinar la rentabilidad real son los gastos operativos, así como la frecuencia de mantenimiento y reparaciones. Nosotros de la empresa Komet estamos convencidos, de que la optimización de los gastos operativos genera la plusvalía para nuestros clientes. Por eso nos concentramos, al desarrollar nuestros productos, en que éstos funcionen con alta fiabilidad, sean de fácil manejo y trabajen siempre con máxima efectividad, permitiéndole así al usuario cuidar los recursos. Soluciones de costos más bajos, a primera vista pueden parecer más económicas. A largo plazo sin embargo, los productos de alta calidad y longevidad, adaptados a las necesidades individuales y de reducidos costos operativos, dan prueba de ser la mejor solución.

# The Advantages / Las Ventajas

**1.**

**WATER DISTRIBUTION**  
**DISTRIBUCIÓN DE AGUA**

**2.**

**CONSISTENCY OF DROPLET SIZE**  
**CONSISTENCIA DEL TAMAÑO DE GOTAS**

**3.**

**ENERGY EFFICIENCY**  
**EFICIENCIA ENERGÉTICA**

**4.**

**RELIABILITY**  
**FIABILIDAD**

**5.**

**ADAPTABILITY**  
**ADAPTABILIDAD**





# Water distribution / Distribución de agua

komet | *Precision Twister (KPT)*

Standard Trajectory Angle / Ángulo de trayectoria estándar

#30 / 6mm Nozzle size / Tamaño de boquilla

10psi / 0.7bar Pressure / Presión

10ft / 3m Spacing / Distancia



# 1

## Distribution / Distribución

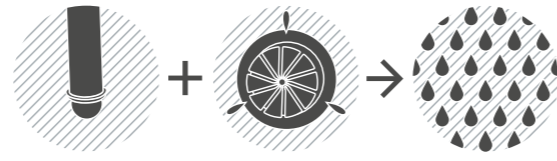

Efficient irrigation is one of the most important factors in crop production. A uniform water application within the wetted pattern, combined with proper overlap of the individual sprinkler patterns, distributes the water evenly across the crop area, giving the water the best opportunity to infiltrate into the root zone. In addition, a uniform water distribution over the entire wetted diameter of the sprinkler keeps the instantaneous application rate low, which reduces the chance of ponding and runoff.

El riego eficiente es uno de los factores más importantes en la producción de cultivos. Una aplicación uniforme de agua, combinado adecuadamente con un traslape apropiado entre los aspersores individuales, asegura una distribución del agua uniforme a través de toda la área de cultivo, y le da al agua la mejor oportunidad de infiltrar la zona de las raíces. Además, una distribución uniforme de agua mantiene baja la tasa de aplicación instantánea, reduciendo así el peligro de encharcamiento y escorrentía.

### Komet 3-Dimensional Motion System

Komet's 3-D Motion System gives the best possible result of uniform water distribution within the whole distribution pattern. The capability of superior water distribution is derived from a combination of components working together, among them, the very responsive 3-D bearing built into the Komet Precision Twister (KPT) sprinkler. This bearing allows the movement of the deflector around the central axis of the sprinkler as well as the deflector's own axis. As the water flows through the sprinkler in its central axis, the deflector oscillates around this central axis, diverting precise amounts of water radially into the air for effective droplet dispersion starting at very low pressures.

### Komet 3-Dimensional Motion System

El Sistema de movimiento 3-D Motion System de Komet, da los mejores resultados posibles en cuanto a una distribución uniforme de agua, dentro del completo patrón de distribución. La capacidad superior de distribución de agua es resultado de una combinación de componentes, entre ellos el muy responsivo accionamiento 3-D, integrado en el aspersor Komet Precision Twister (KPT). Este accionamiento permite al deflector un movimiento alrededor del eje central del aspersor, así como del eje propio del deflector. Con el agua que fluye a través del aspersor en su eje central, el deflector oscila alrededor de este eje central, desviando una exacta cantidad de agua de forma radial al aire, consiguiendo de este modo una dispersión efectiva de gotas, empezando a presiones muy bajas.

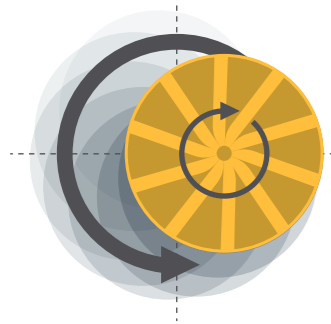
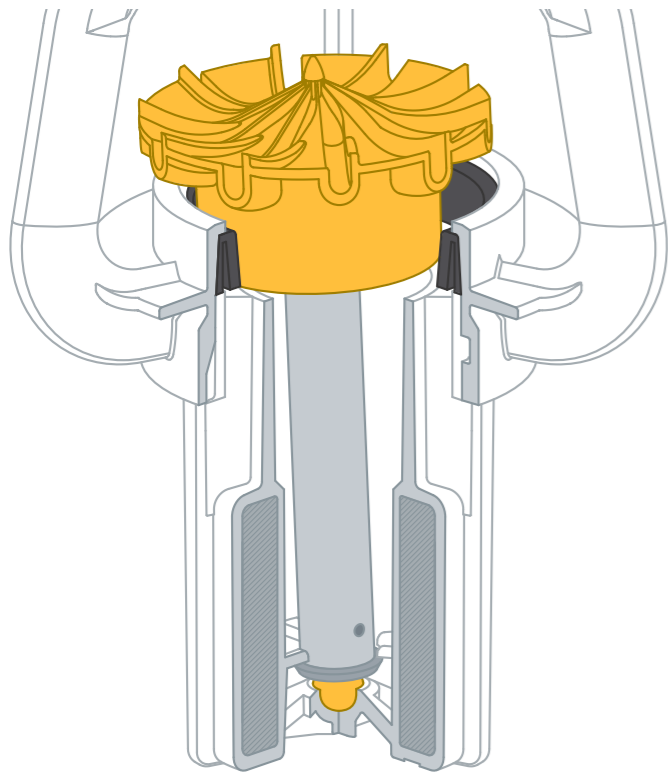

The deflector rotates around the central sprinkler axis as well as its own inclined axis.  
El deflector rota alrededor del eje central del aspersor, así como alrededor de su propio eje inclinado.

### Large wetted diameter

Because of the 3-dimensional motion of the deflector, the water is radially diverted into a sequence of effective, precise amounts of water. This gives the Komet Precision Twister (KPT) its impressive throw, while maintaining consistent distribution uniformity throughout its range of operation.

### Gran diámetro de mojado

Debido al movimiento 3-dimensional del deflector, el agua es desviada de forma radial, en secuencias de cantidades exactas de agua, aportando de este modo al Komet Precision Twister (KPT) su impresionante alcance y manteniendo al mismo tiempo una consistente y uniforme distribución durante su rango de operación.

### Reduced dripping

The specially designed body legs of the Komet Precision Twister (KPT) provide minimal interference for the water streams as they exit the deflector grooves. This combined with the odd number of body legs and the even number of deflector grooves, a configuration unique to the industry, reduces dripping to a minimum.

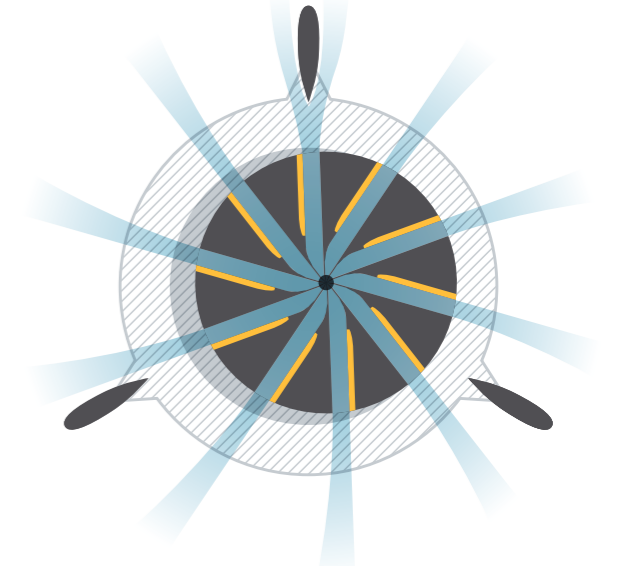

### Reducción del goteo

Del diseño especial de los soportes del cuerpo del Komet Precision Twister (KPT) resulta una interferencia mínima del chorro de agua al salir de las ranuras del deflector. Este factor, combinado con el número impar de soportes del cuerpo y el número par de ranuras del deflector - configuración, única en el mercado - reduce el goteo a un mínimo.

The even number of streams and odd number of specially designed body legs means that only one stream hits a body leg at any given time.

El número par de chorros y el número impar de los soportes del cuerpo, significa que sólo un chorro a la vez toca un soporte del cuerpo.

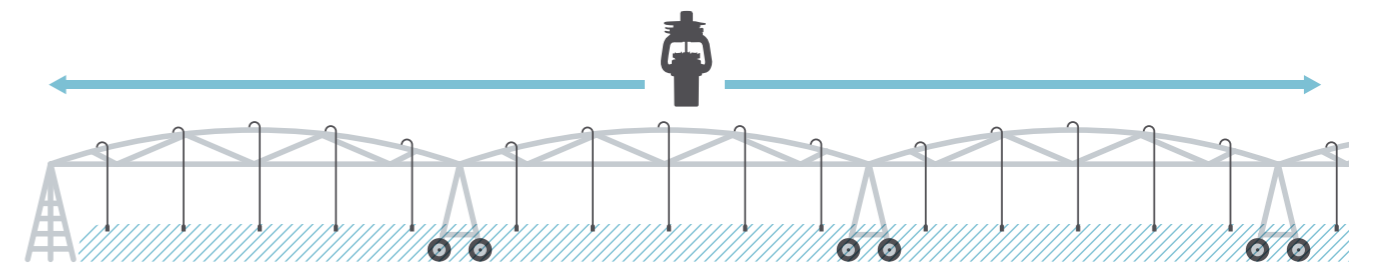

### Komet Universal Pivot Sprinkler

The superior operation of the Komet Precision Twister (KPT) sprinkler also at low pressures and flow rates, and its consistent distribution pattern from the pivot point to the end, allows the use of one sprinkler throughout the entire irrigation system. The sprinkler distributes the water effectively in a pressure range from 6 to 20 psi (0.4 - 1.4 bar) and a nozzle range from 10/128" up to 52/128" (2 - 10.3 mm). This feature is unique to the industry making it unnecessary to use different sprinkler types on the same system. Different sprinklers along one system deliver different water distribution profiles contributing to an overall inferior system performance.

### Komet Aspersor Universal Pivot

El desempeño sobresaliente del aspersor Komet Precision Twister (KPT), tanto referente a presiones bajas como a rangos de caudales bajos, y su uniforme patrón de distribución desde el punto pivotal hasta el final, permiten el uso de un sólo aspersor, a través del entero sistema de irrigación. El aspersor distribuye el agua con eficacia dentro de una gama de presiones de 6 a 20 psi (0.4 - 1.4 bar), y una gama de boquillas de 10/128" a 52/128" (2 - 10.3 mm). Esta característica es única en el mercado, haciéndolo innecesario usar diferentes tipos de aspersores en el mismo sistema. Diferentes aspersores dentro de un sistema, suministran diferentes perfiles de distribución de agua y contribuyen así a un rendimiento inferior del sistema en su conjunto.



**2**

**Consistency of droplet size /  
Consistencia del tamaño de gotas**

komet | *Precision Twister (KPT)*

Standard Trajectory Angle / Ángulo de trayectoria estándar

#30 / 6mm Nozzle size / Tamaño de boquilla

10psi / 0.7bar Pressure / Presión

10ft / 3m Spacing / Distancia



# 2

## Consistency of droplet size / Consistencia del tamaño de gotas



For the best irrigation performance two factors are crucial, reducing the kinetic energy of the water impact onto the soil and controlling wind drift. Delivering a consistent droplet size greatly reduces the loss from wind drift of the fine droplets/mist. In addition, a controlled consistent droplet size and uniform distribution of the droplets within the sprinkler pattern reduces the impact force typical of larger droplets on the soil. These kinds of droplets can cause soil sealing which in turn reduce the soil's water intake rate, increasing the possibility of runoff and thus keeping the water from reaching the target root zone.

Para un óptimo rendimiento del riego, dos factores son cruciales, la reducción de la energía cinética del impacto del agua en el suelo y el control sobre la dispersión causada por viento. El suministro de un consistente tamaño de gotas, reduce en gran medida la pérdida por gotas finas/nebulización, debida al efecto del viento. Además, un controlado y consistente tamaño de gotas y una distribución uniforme de las gotas dentro del patrón del aspersor, reduce la fuerza de impacto típica de gotas mayores sobre el suelo. Este tipo de gotas puede causar un sellado del suelo, que a su vez reduce la tasa de infiltración del agua en el suelo, aumentando así la posibilidad de escorrentía e impidiendo que el agua alcance la zona de las raíces.

### Typical droplet distribution of competitive devices Distribución de gotas en productos de la competencia

Droplets too large  
Gotas demasiado grandes

Droplets too fine  
Gotas demasiado pequeñas

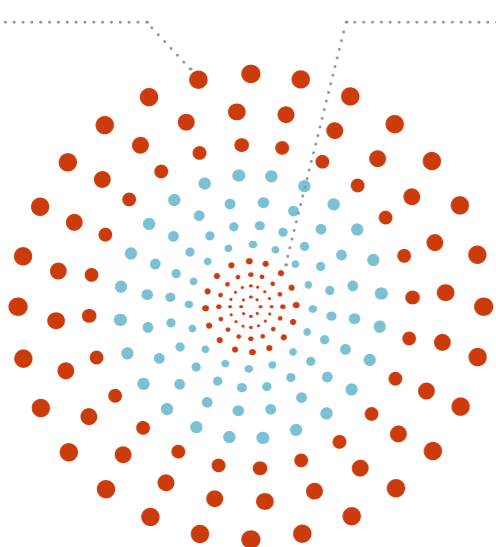

### Komet Precision Twister (KPT) - Droplet distribution Komet Precision Twister (KPT) - Distribución de gotas

Optimized droplet size consistency over whole wetted diameter  
Optimizada consistencia del tamaño de gotas sobre todo el diámetro de mojado

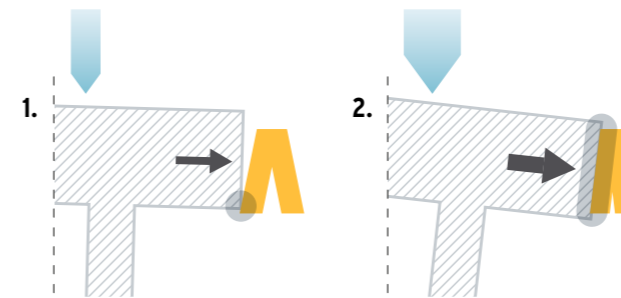
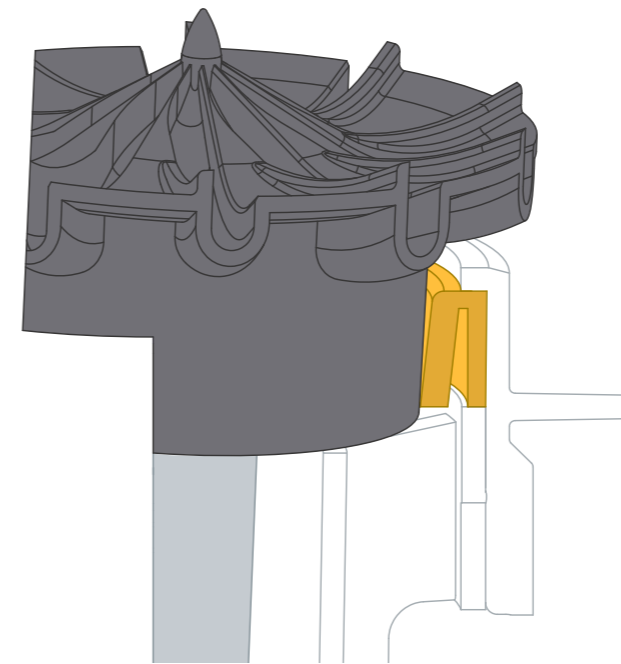
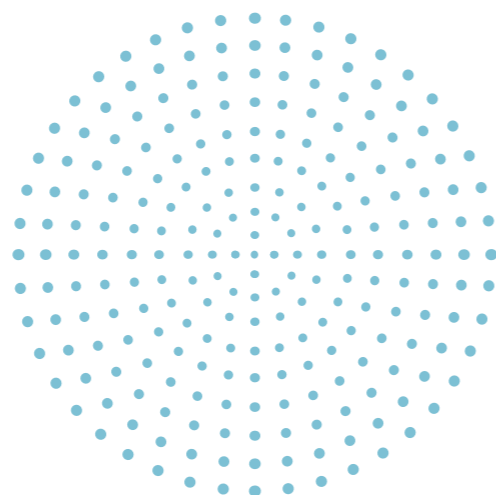

### Komet automatic Motion Control

In addition to the 3-dimensional rotation around the central sprinkler axis, an elastic ring with a flexible inner wall controls the motion of the deflector around its own axis. This feature greatly supports the uniform water distribution of the Komet Precision Twister (KPT) throughout the entire range of pressure and flow conditions.

### Komet Motion Control automático

Además de la rotación 3-dimensional alrededor del eje central del aspersor, un anillo elástico con una pared interior flexible controla el movimiento del deflector alrededor de su propio eje. Esta característica favorece en gran medida la distribución uniforme de agua del Komet Precision Twister (KPT), a través de toda la gama de presiones y condiciones de caudal.

1. In low flow conditions, friction is kept to a minimum for best performance with small nozzles.  
En condiciones de bajo caudal, la fricción es mantenida a un nivel mínimo, para asegurar un óptimo rendimiento con boquillas pequeñas.
2. With increasing flows, the outer ring gradually adapts itself to the deflector for constant performance throughout the whole nozzle range.  
Con el aumento del caudal, el anillo exterior se adapta gradualmente por sí mismo al deflector, para lograr un rendimiento constante en toda la gama de boquillas.

### Komet Deflector and groove configuration

Intensive research and testing made it possible to achieve a droplet distribution pattern that is unique in the industry. The special groove configuration and surface design of the deflector makes sure the water is channeled and properly broken up upon exiting the grooves, dispersing into consistent water droplets over the sprinkler's entire wetted area throughout its range of operation. The Komet Precision Twister (KPT) groove design has been highly engineered to reduce very fine droplets and misting to a minimum in order to maximize the overall system performance.

### Komet Configuración de deflector y ranuras

Intensas investigaciones y pruebas en campo, hicieron posible conseguir un patrón de distribución de gotas, único en la industria. La configuración especial de ranuras y el diseño de la superficie del deflector, garantizan que el agua sea canalizada y dispersada adecuadamente al salir de las ranuras, repartiéndose en consistentes gotas de agua sobre la entera área de mojado del aspersor a través de toda su gama de operaciones. El diseño de ranuras del Komet Precision Twister (KPT), producto de alta ingeniería, fue concebido para reducir al mínimo las gotas finas y la nebulización, con el fin de maximizar el rendimiento del sistema en su conjunto.

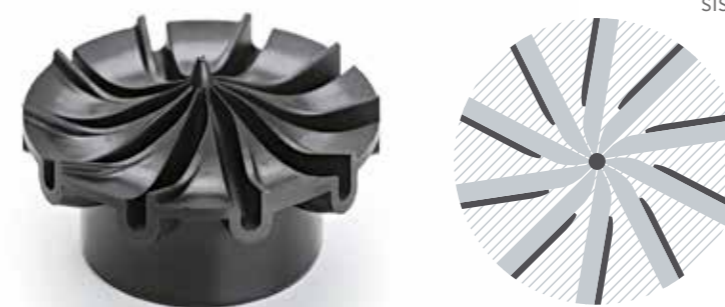

Optimized flow of water through the groove from entrance to exit.  
Flujo optimizado de agua por la ranura, desde la entrada a la salida





**3**

**Energy Efficiency /  
Eficiencia energética**

komet | *Precisión Twister (KPT)*

Standard Trajectory Angle / Ángulo de trayectoria estándar  
#30 / 6mm Nozzle size / Tamaño de boquilla  
Below 6psi / 0.4bar Pressure / Presión abajo de 6psi / 0.4bar



# 3 Energy efficiency / Eficiencia energética



Pressure is a major factor in determining the operating cost of an irrigation system. The higher the pressure required to operate it, the higher the operating cost will be. Finding a method to limit the operating pressure requirement without sacrificing the quality of the water distribution uniformity is ideal. Upgrading the efficiency of the irrigation system can help to increase yields while reducing the operating costs.

La presión determina en gran medida los costos operativos de un sistema de riego. Cuanto más altas las presiones operativas requeridas, tanto más se elevan los costos operativos. Lo ideal es, encontrar un método que logre limitar la presión operativa, sin sacrificar la calidad de distribución uniforme del agua. Mejorar la eficiencia del sistema de riego puede ayudar a aumentar la producción agrícola, reduciendo al mismo tiempo los costos operativos.

## Optimal operating pressure for most common devices / Óptima presión operativa en la mayoría de los dispositivos comunes

Komet Precision Twister	Competitor's distribution device Dispositivo de distribución de la competencia	Competitor's stream device Dispositivo de chorro de la competencia
10 psi	15 psi	20 psi

## Sprinkler Device Efficiencies / Eficiencia de los dispositivos

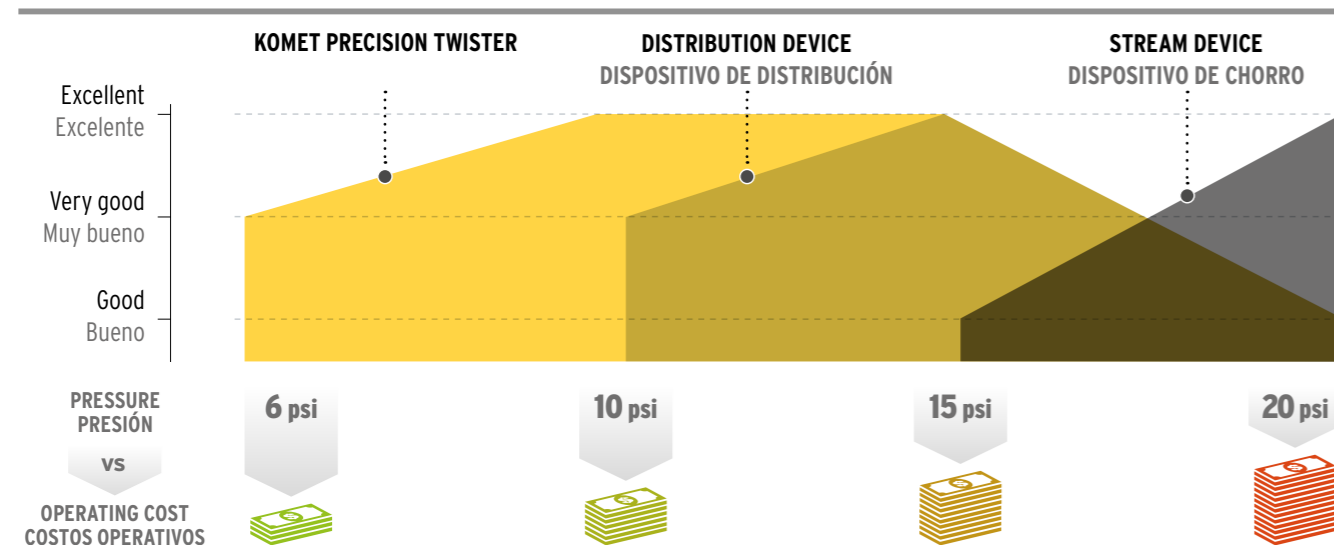

## Komet Low inertia moving parts

Komet has designed a sprinkler that can effectively help reduce energy inputs by allowing the irrigation system to operate at lower pressure while maintaining excellent water distribution uniformity. The Komet 3-dimensional motion system reacts very responsively to minimal pressure and flow levels making the Komet Precision Twister (KPT) sprinkler work more efficiently at lower pressures than other sprinklers. There is no need for additional starting devices built into the sprinkler and therefore no risk of wear of such critical parts that could cause start-up failures.

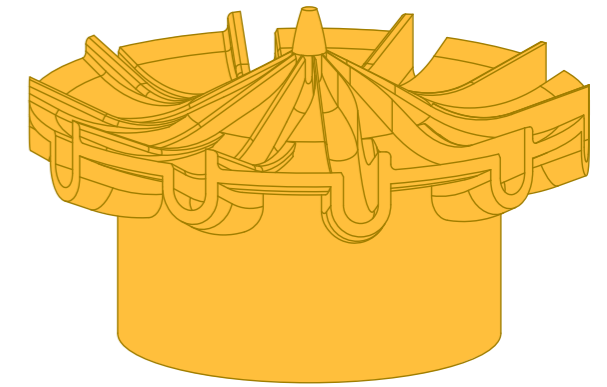

## Komet Elementos móviles de baja inercia

Komet ha diseñado un aspersor que puede ayudar efectivamente a reducir la energía empleada, permitiendo al sistema de irrigación operar a presiones más bajas, manteniendo al mismo tiempo una excelente uniformidad de distribución. El sistema de movimiento 3-dimensional de Komet reacciona de forma muy responsiva, adaptándose a niveles mínimos de presión y caudal y logrando así, que el aspersor Komet Precision Twister (KPT) trabaje con más eficacia a presiones más bajas que otros aspersores. Además no es necesario integrar elementos adicionales de arranque en el aspersor, lo que excluye el riesgo del desgaste de estas partes tan críticas, que pueden causar fallos en la fase de arranque.

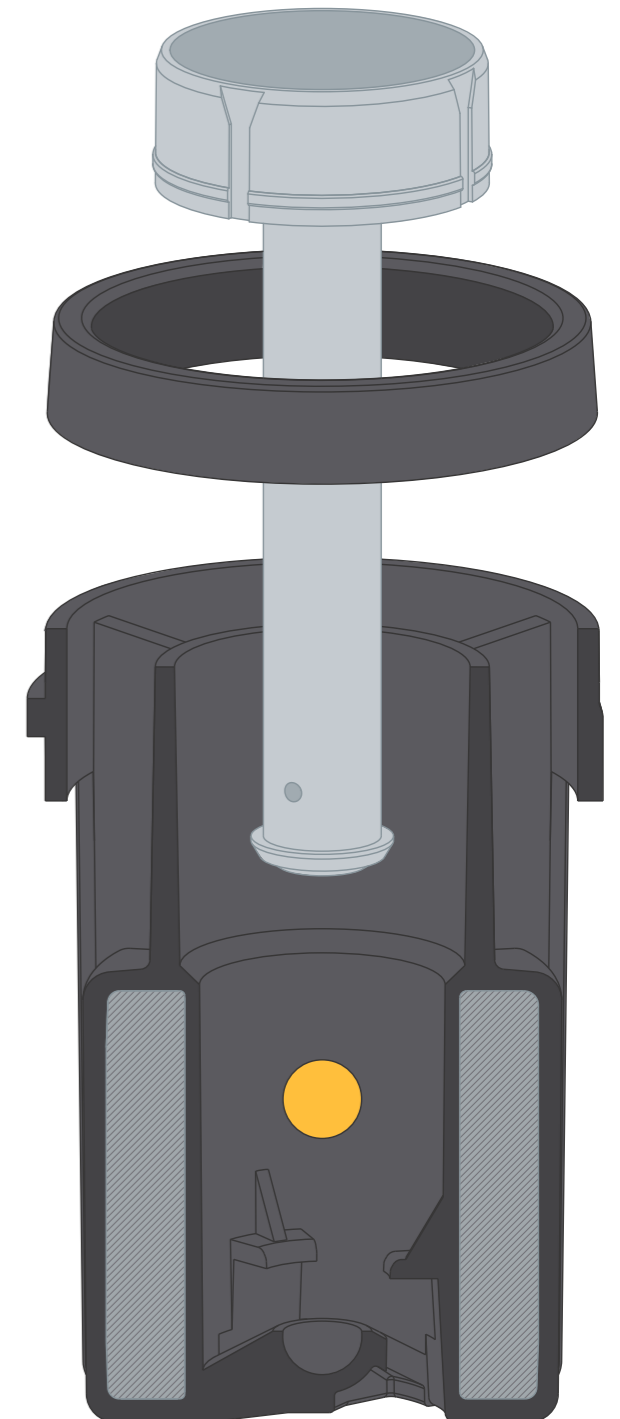

## Komet Operating pressure

In today's farming world, the input costs, such as energy, are closely considered. The design of the innovative Komet Precision Twister (KPT) focuses on efficiency in operation. This precision device has excellent performance at 10 psi and 15 psi and very good performance at 6 psi. Its operating range is the most extended in the industry in this class of device.

## Komet Presión operativa

En el mundo agrícola de hoy, se consideran cuidadosamente los costos operativos como los de energía. El diseño del innovador Komet Precision Twister (KPT) enfoca la eficiencia operativa. Este dispositivo de precisión presenta un excelente rendimiento a presiones de 10 psi y 15 psi, y muy buen rendimiento a 6 psi. Su gama de operaciones es la más extendida en la industria, en esta clase de aspersores.



**4** | **Reliability /  
Fiabilidad**



# 4

## Reliability / Fiabilidad



Intensive farming practices require that every irrigation system operates reliably in order to maximize crop potential. Timing of water application is critical to the potential yield of the crop, especially during dry conditions. Therefore it is essential for growers to use only highly reliable products.

Intensas prácticas agrícolas requieren un funcionamiento fiable de todos los sistemas de irrigación, para maximizar el potencial del cultivo. La temporización del riego es un factor crítico en cuanto al potencial de la cosecha, especialmente durante tiempos de sequía. Por eso es esencial para los productores, usar sólo productos de alta fiabilidad.

### Komet Designed for reliable operation

We believe that reliability needs to be strongly considered in the early stages of product design. The Komet 3-D motion system concentrates the water force onto the patented 3-D bearing situated along the central axis of the sprinkler, thus putting very little stress on the sprinkler assembly. For applications where in-canopy operation is required, a crop guard is built into the main body of the Komet Precision Twister (KPT) sprinkler. The crop guard prevents the deflector from stalling, adding reliability to the sprinkler.

### Komet Desrollado para un funcionamiento fiable

Creemos que la fiabilidad exige un cuidado esmerado, ya en las primeras fases de desarrollo de un producto. El sistema de movimiento 3-D de Komet concentra la fuerza del agua en el accionamiento 3-D, situado a lo largo del eje central del aspersor, lo que a su vez ejerce menos estrés sobre el conjunto del aspersor. Para aplicaciones que requieren operaciones dentro de doseles del cultivo, el aspersor Komet Precision Twister (KPT) tiene integrado en su cuerpo principal, un protector de follaje. Este elemento protector evita que el deflector se estanque, agregándole fiabilidad al aspersor.



A crop guard keeps the deflector rotating also in tall crops. Un elemento protector del follaje mantiene el deflector rotando también en cultivos altos.

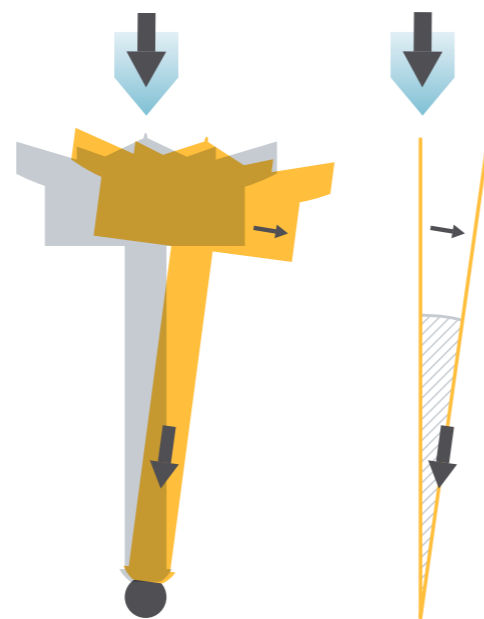

The down force of the water stream is concentrated onto the 3-D bearing situated along the central axis of the sprinkler. The force diagram shows the minimal force put on the elastic ring. La fuerza vertical del chorro de agua se concentra en el accionamiento 3-D, situado a lo largo del eje central del aspersor. El diagrama muestra la fuerza mínima ejercida sobre el anillo elástico.

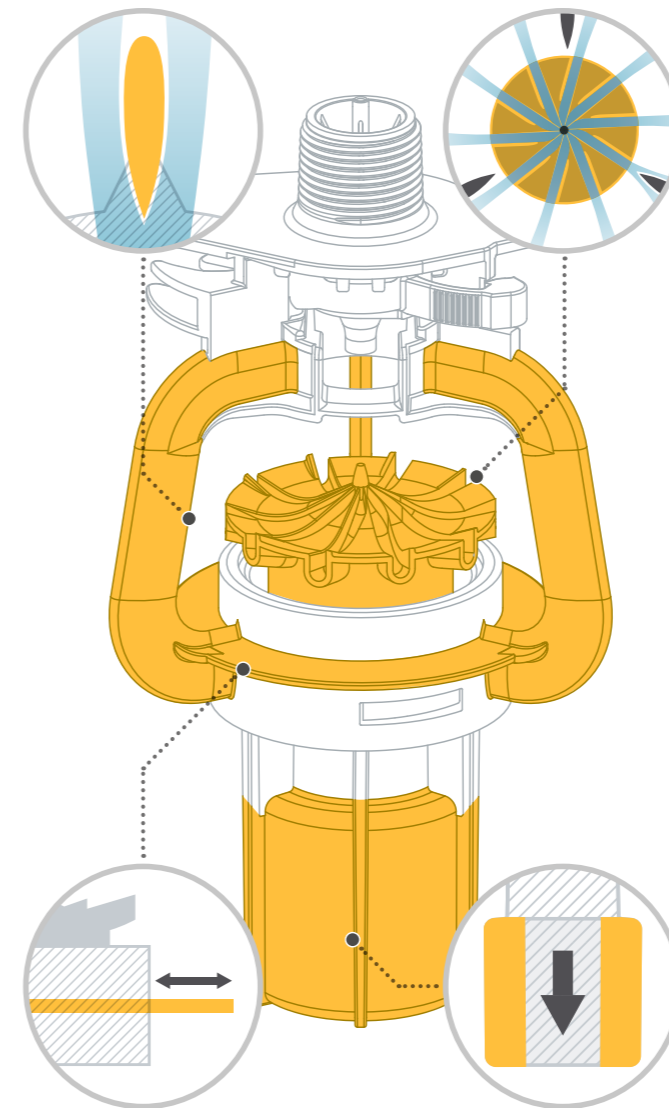

### Komet Smooth operation

The unique configuration of the odd number of the body legs in conjunction with the even number of deflector grooves further contribute to the very smooth operation of the Komet Precision Twister (KPT). The strategic positioning of the integrated weight allows it to keep vibration levels to the lowest in this class of device and helps to keep the sprinkler steady in windy conditions. All of the above factors contribute to the outstanding reliability of the Komet Precision Twister (KPT).

### Komet Óptimo desempeño

La configuración única del número impar de los soportes del cuerpo en combinación con el número par de ranuras del deflector, contribuyen a un muy buen funcionamiento del Komet Precision Twister (KPT). El posicionamiento estratégico del peso integrado, permite mantener las vibraciones a los niveles más bajos dentro de esta clase de dispositivos y ayuda al aspersor mantenerse firme en condiciones de viento. Todos los factores mencionados contribuyen a la fiabilidad sobresaliente del Komet Precision Twister (KPT).

The shape of the body legs contributes to a smooth flow of the water around them. La forma de los soportes del cuerpo facilita el flujo del agua alrededor de ellos.

Only one stream at a time interferes with the body legs for a smooth operation. Sólo un chorro a la vez, interfiere con los soportes del cuerpo, para lograr un buen funcionamiento.

### Komet Quality and materials

The precision manufacturing of every component includes strict quality controls during every manufacturing step and the utmost care in selecting the appropriate materials. The use of shock proof and UV resistant technical polymers, special fiber reinforced and high technology parts are key elements in making the Komet Precision Twister (KPT) a sprinkler of outstanding quality and reliability for most climatic and water conditions.

### Komet Field proven technology

Because reliability is so important to us, we have tested the Komet Precision Twister (KPT) sprinklers over many irrigation seasons. Test sites included a variety of terrains, soils, water conditions, crop types and climatic conditions.

### Komet Calidad y materiales

La precisión con la cual se fabrica cada componente, incluye controles estrictos durante cada etapa de fabricación y sumo cuidado al elegir los materiales apropiados. El uso de polímeros técnicos, resistentes a golpes y radiación UV, fibras reforzadas y partes de alta tecnología, son elementos clave para hacer del Komet Precision Twister (KPT) un aspersor de calidad y fiabilidad sobresalientes, para la mayoría de condiciones climáticas y de agua.

### Komet Tecnología probada en campo

Debido a la importancia que le damos a la fiabilidad, hemos sometido al Komet Precision Twister (KPT) a pruebas durante muchas temporadas de riego. Los sitios de ensayo incluyeron una variedad de terrenos, suelos, condiciones de agua, tipos de cultivo y condiciones climáticas.



komet | *Precision Twister (KPT)*

#30 / 6mm Nozzle size / Tamaño de boquilla

10psi / 0.7bar Pressure / Presión

10ft / 3m Spacing / Distancia



Standard Trajectory Angle /  
Ángulo de trayectoria estándar



5

Adaptability /  
Adaptabilidad



Low Trajectory Angle /  
Ángulo de trayectoria bajo

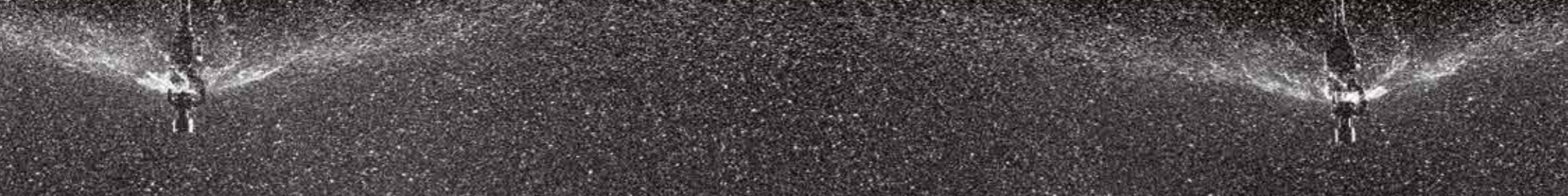

Ultra-Low Trajectory Angle /  
Ángulo de trayectoria ultra-bajo





# 5

## Adaptability / Adaptabilidad



It is fundamental that a pivot sprinkler adapts to different application conditions while maintaining excellent performance. The sprinkler must be able to cope with a wide range of environmental factors such as soil type, terrain, atmospheric conditions, water quality as well as different crops. For optimal irrigation the grower must have the ability to adapt to its prevailing factors.

Es fundamental, que un aspersor pivot se adapte a las diferentes condiciones de aplicación, manteniendo un excelente rendimiento. El aspersor tiene que ser capaz de hacer frente a una amplia gama de factores ambientales, como tipos de suelo, configuración de terrenos, condiciones atmosféricas, calidad de agua, así como cultivos diferentes. Para un riego óptimo, el productor debe tener la habilidad de poder adaptarse a sus factores prevalentes.

### Komet Pivot Sprinkler Applications

Working closely with growers allowed us to identify and develop a unique range of pivot sprinklers that maximize the irrigation efficiency for different application requirements.

For use on drops: Standard angle suitable for most applications. Low angle for applications in windy conditions or where higher ground clearance is required without water interfering with the pivot structure. Ultra-low angle for extreme conditions such as high winds, high heat and/or low flow and where it is most important to get the water to the soil.

For us on top of pipe: Low profile trajectory suitable for all applications when sprinkler installation on top of pipe is required.

Part circle sprinkler: Installed on rigid drops around the towers to direct water off the pivot structure for dry wheel tracks.

### Komet Aplicaciones Aspersores Pivot

Al trabajar estrechamente con los agricultores, hemos podido identificar y desarrollar una gama única de aspersores de pivot, a fin de maximizar la eficiencia del riego, para las diferentes exigencias de aplicación.

Para uso en bajantes: Ángulo estándar, apto para la mayoría de las aplicaciones. Ángulo bajo, apto para aplicaciones en condiciones de viento, o donde es necesaria una mayor distancia entre aspersor y suelo sin interferencia del agua con la estructura del pivot. Ángulo ultra-bajo para condiciones extremas, como viento fuerte, gran calor y/o caudal bajo, así como, donde lo más importante es, que el agua llegue al suelo. Para uso encima del tubo: Trayectoria de bajo perfil, apto para todas las aplicaciones que requieren una instalación encima del tubo.

Aspersor círculo parcial: Instalado en bajantes rígidos alrededor de las torres, para dirigir el agua fuera de la estructura del pivot. Para huellas de las ruedas secas.

Standard Trajectory Angle Ángulo de trayectoria estándar	Low Trajectory Angle Ángulo de trayectoria bajo	Ultra-Low Trajectory Angle Ángulo de trayectoria ultra-bajo	Low Profile Trajectory Angle Ángulo de trayectoria de bajo perfil	Part Circle PC180 Círculo Parcial PC180
For use on drops Para uso en bajante	For use on drops Para uso en bajante	For use on drops Para uso en bajante	For use on top of pipe Para uso encima del tubo	For use on rigid drops Para uso en bajantes rígidos

### Komet Rapid Fit Nozzle System

The Komet Rapid Fit Nozzle System allows for a fast and easy installation of the nozzle into the sprinkler. There is no need to remove the sprinkler from the drop assembly should the nozzle be plugged or in case it needs to be changed for different flow requirements. The nozzle can be removed for cleaning or replacing while the sprinkler is operating.



1. Insert  
Insertar



2. Rotate to install  
Rotar para instalar



3. Click to secure  
Presionar hasta el clic para fijarlo

### Komet Integrated additional Nozzle Carrier

The Komet Precision Twister (KPT) comes with a 2<sup>nd</sup> nozzle carrier integrated into the sprinkler body. It is very useful should the irrigation require different flow rates during the irrigation season.



### Komet Soporte de boquilla adicional integrado

El Komet Precision Twister (KPT) viene con un soporte para una segunda boquilla, integrado en su cuerpo. Esto es muy útil, en casos de que el riego requiera diferentes gamas de caudales durante la temporada de riego.

### Komet Truss Rod Clip

Lowering the application rate, can be a decisive advantage in irrigation. A suitable solution is to increase the wetted area by using drops over the truss rod, fixed with the Komet Truss Rod Clip. The design of the Komet Truss Rod Clip allows for an easy fixation on the truss rod while maintaining the natural shape of the hose. To facilitate selection, 4 models with two size combinations each are available, covering all common rod sizes.

### Komet Truss Rod Clip

Reducir la tasa de aplicación puede ser una ventaja decisiva en el riego. Una solución adecuada es la extensión de la area mojada, montando mangueras flexibles del bajante encima de los tirantes y fijándolos con el Komet Truss Rod Clip. El diseño del Komet Truss Rod Clip permite una fácil instalación en los tirantes, manteniendo la forma natural de la manguera. Para facilitar la selección, están disponibles 4 modelos, cada uno con dos combinaciones de tamaños, que cubren todos los tamaños corrientes de tirante.







**komet** | *Pivot*

---

Komet Precision Twister (KPT)

Komet Precision Spray (KPS)

Rapid Fit Nozzle (RFN)







komet | *Precision Twister (KPT)*

Standard Trajectory Angle / Ángulo de trayectoria estándar  
#29-31 / 5.8-6.2mm Nozzle sizes / Tamaño de boquillas  
10psi / 0.7bar Pressure / Presión  
10ft / 3m Spacing / Distancia



# komet | Rapid Fit Nozzle

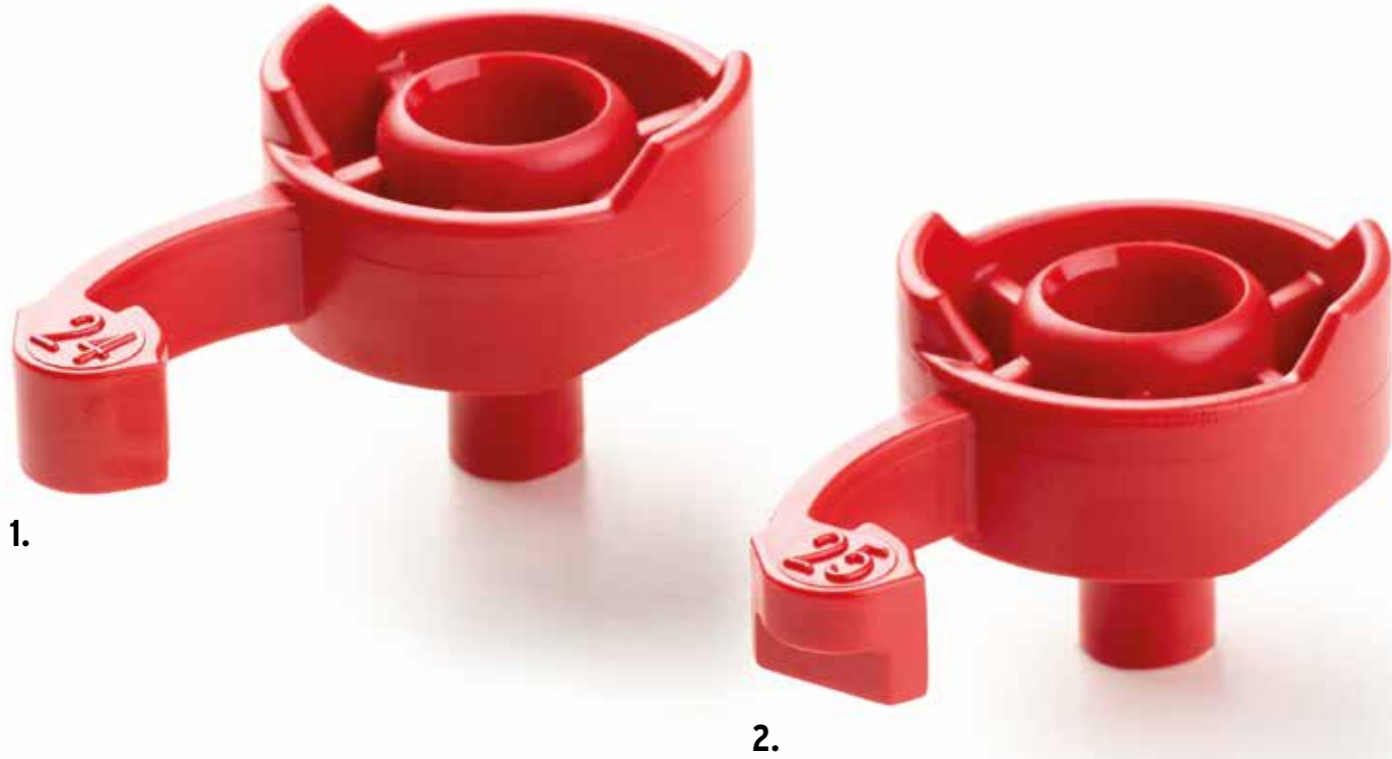

1.

2.

## Nozzle Identification

Nozzles are identified by the industry standard color code and orifice sizes are based on 128th inch increments.

1.

All **EVEN** nozzle sizes have a full tip of the lever.

2.

All **ODD** nozzle sizes have a notched tip of the lever.

## Identificación de las boquillas

Las boquillas se identifican por el código industrial estándar de colores, los tamaños de los orificios se basan en incrementos de 128 pulgadas.

1.

Todos los tamaños de boquillas de número **PAR** tienen una extremidad completa de palanca.

2.

Todos los tamaños de las boquillas de número **IMPAR** tienen una extremidad dentada de palanca.

komet	Rapid Fit Nozzle		US UNITS (GPM) DATOS TÉCNICOS UNIDADES US UNITS				METRIC UNITS (L/Hr) DATOS TÉCNICOS UNIDADES METRICAS				
			Pressure at nozzle / Presión a la boquilla				Pressure at nozzle / Presión a la boquilla				
			6 PSI	10 PSI	15 PSI	20 PSI	0,41 bar	0,69 bar	1,03 bar	1,38 bar	
Nozzle size in 1/128" increments Tamaño boquilla incrementos de 1/128"		COLOR / COLORES		Flow / Caudal (GPM)				Flow / Caudal (L/Hr)			
8	Light Blue	Azul claro	0,24	0,31	0,38	0,45	54,2	71,0	87,3	101,6	
9	Light Blue	Azul claro	0,34	0,44	0,54	0,63	76,9	100,5	123,4	143,3	
10	Beige	Beige	0,43	0,55	0,68	0,79	96,7	126,0	154,5	179,3	
11	Beige	Beige	0,51	0,66	0,81	0,95	115,0	150,5	185,1	215,3	
12	Gold	Oro	0,60	0,79	0,97	1,13	136,4	178,8	220,0	256,1	
13	Gold	Oro	0,71	0,92	1,13	1,32	160,5	209,7	257,6	299,3	
14	Lime	Limón	0,83	1,09	1,34	1,56	189,0	247,3	304,2	353,9	
15	Lime	Limón	0,95	1,24	1,52	1,76	214,8	280,6	344,7	400,5	
16	Lavender	Lavanda	1,09	1,42	1,75	2,03	247,0	322,8	396,6	460,9	
17	Lavender	Lavanda	1,22	1,60	1,97	2,29	277,8	363,5	447,1	520,0	
18	Grey	Gris	1,39	1,81	2,23	2,59	315,4	411,7	505,5	587,2	
19	Grey	Gris	1,55	2,03	2,49	2,90	352,0	460,3	566,0	658,1	
20	Turquoise	Turquesa	1,73	2,25	2,77	3,21	392,4	512,0	628,3	729,6	
21	Turquoise	Turquesa	1,90	2,48	3,05	3,54	432,1	563,8	692,0	803,6	
22	Yellow	Amarillo	2,10	2,74	3,36	3,90	477,8	622,5	763,2	885,6	
23	Yellow	Amarillo	2,32	3,01	3,67	4,24	527,6	683,0	833,1	963,2	
24	Red	Rojo	2,51	3,27	4,01	4,65	571,2	743,1	910,0	1055,1	
25	Red	Rojo	2,70	3,51	4,30	4,99	613,0	797,8	977,2	1133,2	
26	White	Blanco	2,93	3,81	4,67	5,41	666,5	866,5	1060,3	1228,7	
27	White	Blanco	3,15	4,09	5,00	5,80	714,6	928,7	1136,2	1316,4	
28	Blue	Azul	3,42	4,44	5,43	6,30	775,8	1008,5	1234,1	1430,2	
29	Blue	Azul	3,64	4,73	5,79	6,71	826,5	1074,7	1315,4	1524,5	
30	Dark Brown	Marrón oscuro	3,92	5,09	6,23	7,23	890,1	1157,1	1416,0	1641,0	
31	Dark Brown	Marrón oscuro	4,17	5,42	6,63	7,68	946,2	1230,4	1505,9	1745,3	
32	Orange	Naranja	4,42	5,75	7,03	8,15	1003,7	1304,9	1597,0	1850,8	
33	Orange	Naranja	4,56	5,93	7,26	8,42	1036,3	1347,6	1649,5	1911,9	
34	Dark Green	Verde oscuro	4,92	6,37	7,77	8,97	1118,1	1446,6	1763,7	2038,4	
35	Dark Green	Verde oscuro	5,20	6,77	8,29	9,62	1181,1	1537,5	1883,5	2184,4	
36	Purple	Violeta	5,51	7,18	8,80	10,22	1251,5	1630,9	1999,5	2320,4	
37	Purple	Violeta	5,82	7,58	9,28	10,77	1321,9	1721,0	2108,6	2445,6	
38	Black	Negro	6,15	8,01	9,82	11,39	1397,0	1819,5	2229,9	2586,9	
39	Black	Negro	6,48	8,44	10,35	12,01	1471,4	1917,5	2351,1	2728,4	
40	Dark Turquoise	Turquesa osc.	6,84	8,89	10,89	12,62	1552,6	2019,9	2473,3	2867,4	
41	Dark Turquoise	Turquesa osc.	7,16	9,33	11,43	13,26	1625,9	2118,0	2595,9	3011,7	
42	Mustard	Mostaza	7,51	9,78	11,99	13,91	1704,6	2221,2	2723,2	3160,1	
43	Mustard	Mostaza	7,93	10,33	12,67	14,71	1801,1	2347,3	2878,2	3340,2	
44	Maroon	Granate	8,33	10,85	13,30	15,44	1890,9	2464,3	3021,5	3506,4	
45	Maroon	Granate	8,65	11,25	13,79	15,99	1963,8	2556,3	3131,3	3631,4	
46	Cream	Crema	9,09	11,85	14,52	16,85	2065,0	2690,6	3298,4	3827,3	
47	Cream	Crema	9,46	12,30	15,06	17,46	2147,6	2793,6	3420,3	3965,0	
48	Dark Blue	Azul oscuro	9,88	12,85	15,74	18,24	2243,1	2918,6	3574,0	4143,8	
49	Dark Blue	Azul oscuro	10,29	13,39	16,40	19,02	2336,0	3040,7	3724,7	4319,6	
50	Copper	Cobre	10,71	13,94	17,08	19,80	2432,8	3166,6	3878,8	4498,2	
51	Copper	Cobre	11,08	14,41	17,65	20,47	2516,1	3273,9	4009,3	4648,6	
52	Gold	Oro	11,52	15,01	18,39	21,33	2616,9	3408,3	4176,9	4845,5	

Disclaimer: The table above represents the flow of each nozzle at nominal and constant pressure, not considering the regulator performance curve. This flow data was obtained under ideal testing conditions and may be affected by poor hydraulic flow conditions, turbulence and other conditions.  
Aviso: La tabla anterior representa el caudal de cada boquilla a presión nominal y constante, sin considerar la curva del rendimiento del regulador. Estos datos referentes al caudal fueron obtenidos bajo condiciones de ensayo ideales, y pueden ser afectados por un deficiente flujo hidráulico, turbulencias y otras condiciones.



# komet | Precision Twister (KPT)

Key features  
Características clave

Integrated additional Nozzle Carrier  
Soporte de boquilla adicional integrado

Innovative automatic  
Motion Control System  
Sistema innovador  
Motion Control  
automático

Komet Twister Deflector System:  
standard / low / ultra-low trajectories  
Komet Twister sistema de deflectores  
Trayectorias estándar / baja / ultra-baja

Innovative 3-D Motion System  
Innovador 3-D Motion System

Komet integrated weight  
Komet peso integrado  
0,75 lb / 350 gr



Integrated adapter  
Adaptador integrado

Komet Rapid Fit Nozzle System  
Nozzle range 10 - 52/128"  
Komet Rapid Fit sistema de boquillas  
Gama de boquillas 10-52/128"

Plug resistant extra-wide body  
Cuerpo extra ancho, resistente  
a atascos



Internal width  
Anchura interna  
3.00" / 76 mm

Internal height  
Altura interna  
2.04" / 52 mm

Crop Guard  
Protector del follaje

Dimensions /  
Medidas



7.65" / 195 mm

4.65" / 118 mm



Available Models  
Modelos disponibles

### Komet Precision Twister (KPT)



#### STANDARD TRAJECTORY ANGLE

Standard Angle with multi trajectory suitable for most applications. Unmatched droplet size consistency over the entire throw and nozzle range. Large wetted diameter and gentle water application with low instantaneous application.

#### TRAYECTORIA ÁNGULO ESTÁNDAR

Ángulo estándar con trayectorias múltiples para la mayoría de aplicaciones. Incomparable consistencia de tamaño de gotas, a lo largo del entero alcance y en toda la gama de boquillas. Extenso diámetro de mojado y aplicación suave de agua con baja aplicación instantánea.

### Komet Precision Twister (KPT)



#### LOW TRAJECTORY ANGLE

Low Angle with multi trajectory suitable for applications in windy conditions. Unmatched droplet size consistency over the entire throw and nozzle range. Large wetted diameter with reduced wind drift.

#### TRAYECTORIA ÁNGULO BAJO

Ángulo bajo con trayectorias múltiples para aplicaciones en condiciones de viento. Incomparable consistencia de tamaño de gotas, a lo largo del entero alcance y en toda la gama de boquillas. Extenso diámetro de mojado con reducida dispersión por viento.

### Komet Precision Twister (KPT)



#### ULTRA-LOW TRAJECTORY ANGLE

Ultra-Low Angle with multi trajectory suitable for applications in high wind, high heat conditions and/or low flow. Unmatched droplet size consistency over the entire throw and nozzle range. Very little wind drift.

#### TRAYECTORIA ÁNGULO ULTRA-BAJO

Ángulo ultra-bajo con trayectorias múltiples para aplicaciones en condiciones de viento fuerte o gran calor. Incomparable consistencia de tamaño de gotas, a lo largo entero del alcance y en toda la gama de boquillas. Muy poca dispersión por viento.

Available Models  
Modelos disponibles

### Komet Precision Twister (KPT) Peak



#### LOW PROFILE TRAJECTORY FOR USE ON TOP OF PIPE

Low Profile Multi-Trajectory suitable for all on top of pipe applications with unmatched droplet size consistency. Large wetted diameter, gentle water application with low instantaneous application, and reduced wind drift. Komet KPT-Link connector required for installation.

#### TRAYECTORIA DE BAJO PERFIL PARA USO ENCIMA DEL TUBO

Trayectoria múltiple de bajo perfil, adecuada para todas las instalaciones encima del tubo, con una incomparable consistencia del tamaño de gotas. Amplio diámetro de mojado, aplicación de agua suave con baja aplicación instantánea y reducida dispersión por viento. Para la instalación es necesario el conector Komet KPT-Link.

### Komet Precision Twister (KPT) PC180



#### PART CIRCLE FOR USE ON RIGID DROPS

Part Circle Sprinkler with 180 degree wetted pattern used for dry wheel tracks. Standard Angle with multi jet trajectory. Unmatched droplet size consistency over the entire throw and nozzle range. Gentle water application with low instantaneous application.

#### CÍRCULO PARCIAL PARA USO EN BAJANTES RÍGIDOS

Aspersor Círculo Parcial, con área mojado de 180 grados, usado para huellas de las ruedas secas. Ángulo estándar con trayectorias múltiples. Incomparable consistencia de tamaño de gotas, a lo largo del entero alcance y en toda la gama de boquillas. Aplicación suave de agua con baja aplicación instantánea.





Performance data / Datos de rendimiento



**komet | Precision Twister (KPT)** **STANDARD TRAJECTORY ANGLE**  
**TRAYECTORIA ÁNGULO ESTÁNDAR**

Deflector Specifications / Especificaciones del deflector		Operating Parameters / Parámetros operativos					Installation / Instalación
Trajectory / Trayectoria	Grooves / Ranuras	Nozzle range / Gama boquillas (mm)	Pressure range / Gama presiones (bar)	Flow range / Gama caudales (l/hr)	Spacing max. / Distancia máx. (m)	Drop Type / Tipo bajante	
Standard Angle / Ángulo estándar	10	2,0 - 10,3	0,41 - 1,38	100,7 - 4844,4	6,1	Flex hose / Manguera flexible Poly Pipe / Tubo Polietileno	

Nozzle Size / Tamaño boquilla		Throw Diameter / Diámetro alcance D (m)												Stream Height / Altura chorro S (m)			
		Installation Height / Altura instalación H=0,9m				Installation Height / Altura instalación H=1,8m				Installation Height / Altura instalación H=2,7m							
		Pressure / Presión (bar)		Pressure / Presión (bar)		Pressure / Presión (bar)		Pressure / Presión (bar)		Pressure / Presión (bar)		Pressure / Presión (bar)					
mm	1/128"	0,41	0,69	1,03	1,38	0,41	0,69	1,03	1,38	0,41	0,69	1,03	1,38	0,41	0,69	1,03	1,38
2,0	10	8,2	10,2	11,8	12,8	10,0	12,0	13,6	14,6	11,3	13,2	14,9	15,9	0,55	0,79	0,87	1,13
3,2	16	9,5	11,5	13,2	14,1	11,3	13,3	15,0	15,9	12,6	14,6	16,3	17,2	0,65	0,85	0,91	1,15
4,6	23	10,6	12,6	14,3	15,3	12,4	14,4	16,1	17,1	13,7	15,7	17,4	18,3	0,69	0,85	1,00	1,21
5,8	29	11,2	13,2	14,9	15,8	13,0	15,0	16,7	17,6	14,3	16,3	18,0	18,9	0,70	0,87	1,10	1,25
6,7	34	11,5	13,4	15,1	16,1	13,3	15,2	16,9	17,9	14,5	16,5	18,2	19,2	0,70	0,87	1,17	1,25
7,9	40	11,4	13,4	15,1	16,0	13,2	15,2	16,9	17,8	14,5	16,5	18,2	19,1	0,70	0,90	1,17	1,25
8,9	45	11,1	13,1	14,8	15,8	12,9	14,9	16,6	17,6	14,2	16,2	17,9	18,8	0,70	0,92	1,17	1,25
10,3	52	10,3	12,3	14,0	15,0	12,1	14,1	15,8	16,8	13,4	15,4	17,1	18,0	0,70	0,92	1,17	1,25



**komet | Precision Twister (KPT)** **LOW TRAJECTORY ANGLE**  
**TRAYECTORIA ÁNGULO BAJO**

Deflector Specifications / Especificaciones del deflector		Operating Parameters / Parámetros operativos					Installation / Instalación
Trajectory / Trayectoria	Grooves / Ranuras	Nozzle range / Gama boquillas (mm)	Pressure range / Gama presiones (bar)	Flow range / Gama caudales (l/hr)	Spacing max. / Distancia máx. (m)	Drop Type / Tipo bajante	
Low Angle / Ángulo bajo	10	2,0 - 10,3	0,41 - 1,38	100,7 - 4844,4	5,5	Flex hose / Manguera flexible Poly Pipe / Tubo Polietileno	

Nozzle Size / Tamaño boquilla		Throw Diameter / Diámetro alcance D (m)												Stream Height / Altura chorro S (m)			
		Installation Height / Altura instalación H=0,9m				Installation Height / Altura instalación H=1,8m				Installation Height / Altura instalación H=2,7m							
		Pressure / Presión (bar)		Pressure / Presión (bar)		Pressure / Presión (bar)		Pressure / Presión (bar)		Pressure / Presión (bar)		Pressure / Presión (bar)					
mm	1/128"	0,41	0,69	1,03	1,38	0,41	0,69	1,03	1,38	0,41	0,69	1,03	1,38	0,41	0,69	1,03	1,38
2,0	10	7,4	9,4	11,0	11,9	9,5	11,4	13,1	14,0	11,0	12,9	14,6	15,5	0,32	0,46	0,63	0,70
3,2	16	8,6	10,6	12,2	13,1	10,7	12,6	14,3	15,2	12,2	14,1	15,8	16,7	0,32	0,47	0,64	0,70
4,6	23	9,6	11,5	13,2	14,1	11,7	13,6	15,2	16,1	13,2	15,1	16,7	17,6	0,33	0,48	0,65	0,72
5,8	29	10,1	12,0	13,7	14,5	12,1	14,1	15,7	16,6	13,6	15,6	17,2	18,1	0,33	0,48	0,65	0,72
6,7	34	10,2	12,2	13,8	14,7	12,3	14,2	15,9	16,7	13,8	15,7	17,4	18,2	0,33	0,48	0,65	0,75
7,9	40	10,1	12,0	13,7	14,5	12,1	14,1	15,7	16,6	13,6	15,6	17,2	18,1	0,33	0,50	0,65	0,75
8,9	45	9,7	11,7	13,3	14,2	11,8	13,7	15,4	16,2	13,3	15,2	16,9	17,7	0,32	0,50	0,65	0,75
10,3	52	8,8	10,8	12,4	13,3	10,9	12,8	14,5	15,4	12,4	14,3	16,0	16,9	0,32	0,50	0,65	0,75

For optimal performance of the Komet Precision Twister (KPT) when installed on drop pipes, it is recommended to use the maximum spacing up to the 2nd span only. Keep the Komet Precision Twister (KPT) out of the crop canopy when spacing exceeds 3 m. Install the Komet Precision Twister (KPT) with a ground clearance of at least 1 m. Performance data regarding flow and throw in relation to installation height and deflector type shown in the tables, originate from the mathematical model used in the Komet Pivot Calculator software. Performance data was obtained under ideal testing conditions and is the base for the mathematical model. Pressure refers to pressure at nozzle. Stream height is the height from the deflector to the highest droplets in the trajectory profile. Performance may be adversely affected by wind and other factors.

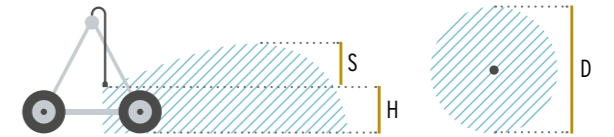

Performance data / Datos de rendimiento



**komet | Precision Twister (KPT)** **ULTRA-LOW TRAJECTORY ANGLE**  
**TRAYECTORIA ÁNGULO ULTRA-BAJO**

Deflector Specifications / Especificaciones del deflector		Operating Parameters / Parámetros operativos					Installation / Instalación
Trajectory / Trayectoria	Grooves / Ranuras	Nozzle range / Gama boquillas (mm)	Pressure range / Gama presiones (bar)	Flow range / Gama caudales (l/hr)	Spacing max. / Distancia máx. (m)	Drop Type / Tipo bajante	
Ultra-Low Angle / Ángulo ultra-bajo	10	2,0 - 10,3	0,41 - 1,38	100,7 - 4844,4	4,6	Flex hose / Manguera flexible Poly Pipe / Tubo Polietileno	

Nozzle Size / Tamaño boquilla		Throw Diameter / Diámetro alcance D (m)												Stream Height / Altura chorro S (m)			
		Installation Height / Altura instalación H=0,9m				Installation Height / Altura instalación H=1,8m				Installation Height / Altura instalación H=2,7m							
		Pressure / Presión (bar)		Pressure / Presión (bar)		Pressure / Presión (bar)		Pressure / Presión (bar)		Pressure / Presión (bar)		Pressure / Presión (bar)					
mm	1/128"	0,41	0,69	1,03	1,38	0,41	0,69	1,03	1,38	0,41	0,69	1,03	1,38	0,41	0,69	1,03	1,38
2,0	10	6,4	8,2	9,7	10,7	9,0	10,8	12,4	13,3	10,7	12,5	14,1	15,1	0,12	0,16	0,26	0,27
3,2	16	7,5	9,3	10,9	11,8	10,1	11,9	13,5	14,4	11,8	13,6	15,2	16,2	0,11	0,17	0,19	0,25
4,6	23	8,3	10,2	11,7	12,7	11,0	12,8	14,4	15,3	12,7	14,5	16,1	17,1	0,11	0,17	0,19	0,31
5,8	29	8,8	10,6	12,2	13,1	11,4	13,2	14,8	15,7	13,1	15,0	16,5	17,5	0,11	0,17	0,20	0,33
6,7	34	8,9	10,7	12,3	13,2	11,5	13,3	14,9	15,8	13,2	15,1	16,6	17,6	0,11	0,17	0,20	0,37
7,9	40	8,7	10,5	12,1	13,0	11,3	13,1	14,7	15,7	13,1	14,9	16,5	17,4	0,11	0,17	0,20	0,37
8,9	45	8,3	10,1	11,7	12,7	10,9	12,7	14,3	15,3	12,7	14,5	16,1	17,0	0,11	0,19	0,21	0,37
10,3	52	7,4	9,2	10,8	11,7	10,0	11,8	13,4	14,4	11,8	13,6	15,2	16,1	0,11	0,19	0,21	0,37

Para un óptimo rendimiento del Komet Precision Twister (KPT) es recomendable que, al instalar las tuberías de los bajantes, se use la máxima distancia sólo hasta el segundo tramo. Mantenga el Komet Precision Twister (KPT) fuera del dosel del cultivo, si la distancia sobrepasa 3 m. Instale el Komet Precision Twister (KPT) con una distancia del suelo al aspersor de por lo menos 1 m. Los datos de rendimiento, referentes a caudal y alcance en relación a la altura de instalación y tipo de deflector, que figuran en la tabla, tienen su origen en el modelo matemático, usado en el software del Komet Pivot Calculator. Los datos de rendimiento fueron obtenidos bajo condiciones de ensayo ideales y son base del modelo matemático. La presión se refiere a la presión a la boquilla. La altura del chorro se refiere a la altura a partir del deflector, hasta el punto más alto del perfil del chorro. Los datos referentes al caudal fueron obtenidos bajo condiciones de ensayo ideales y pueden ser afectados por un deficiente flujo hidráulico, turbulencias y otras condiciones.



Performance data / Datos de rendimiento

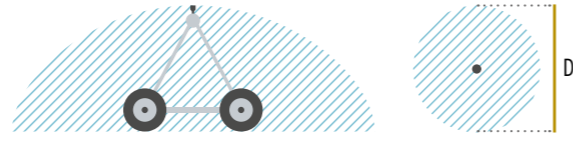

**komet | Precision Twister (KPT) Peak** **LOW PROFILE TRAJECTORY**  
**TRAYECTORIA DE BAJO PERFIL**

Deflector Specifications / Especificaciones del deflector		Operating Parameters / Parámetros operativos				Installation / Instalación
Trajectory / Trayectoria	Grooves / Ranuras	Nozzle range / Gama boquillas (mm)	Pressure range / Gama presiones (bar)	Flow range / Gama caudales (l/hr)	Spacing max. / Distancia máx. (m)	Top of pipe / Encima del tubo
Low Profile Trajectory / Trayectoria de bajo perfil	10	2,0 - 10,3	0,41 - 1,38	100,7 - 4844,4	6,1	KPT-Link connector required / Conector KPT-Link necesario

Nozzle Size / Tamaño boquilla		Throw Diameter / Diámetro alcance D (m)								Stream Height / Altura chorro S (m)			
		Installation Height / Altura instalación H=2,2m				Installation Height / Altura instalación H=4,0m							
		Pressure / Presión (bar)		Pressure / Presión (bar)		Pressure / Presión (bar)		Pressure / Presión (bar)		Pressure / Presión (bar)			
mm	1/128"	0,41	0,69	1,03	1,38	0,41	0,69	1,03	1,38	0,41	0,69	1,03	1,38
2,0	10	9,8	11,7	13,5	15,0	12,0	13,9	15,7	17,2				
3,2	16	10,2	12,1	14,0	15,4	12,4	14,2	16,2	17,6				
4,6	23	10,7	12,5	14,4	15,9	12,9	14,8	16,6	18,1				
5,8	29	11,0	12,8	14,7	16,2	13,2	15,1	17,0	18,4				
6,7	34	11,2	13,1	15,0	16,4	13,4	15,3	17,2	18,7				
7,9	40	11,5	13,3	15,2	16,7	13,7	15,6	17,4	18,9				
8,9	45	11,6	13,5	15,4	16,8	13,8	15,7	17,6	19,1				
10,3	52	11,8	13,7	15,5	17,0	14,0	15,9	17,7	19,2				

LOW PROFILE  
BAJO PERFIL

For optimal performance of the Komet Precision Twister (KPT) when installed on drop pipes, it is recommended to use the maximum spacing up to the 2nd span only. Keep the Komet Precision Twister (KPT) out of the crop canopy when spacing exceeds 3 m. Install the Komet Precision Twister (KPT) with a ground clearance of at least 1 m. Performance data regarding flow and throw in relation to installation height and deflector type shown in the tables, originate from the mathematical model used in the Komet Pivot Calculator software. Performance data was obtained under ideal testing conditions and is the base for the mathematical model. Pressure refers to pressure at nozzle. Stream height is the height from the deflector to the highest droplets in the trajectory profile. Performance may be adversely affected by wind and other factors.

Performance data / Datos de rendimiento

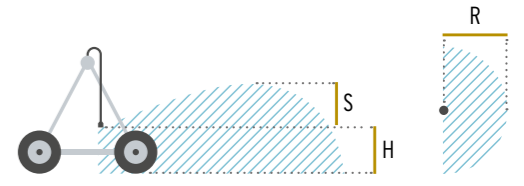

**komet | Precision Twister (KPT) PC180** **PART CIRCLE**  
**CÍRCULO PARCIAL**

Deflector Specifications / Especificaciones del deflector		Operating Parameters / Parámetros operativos				Installation / Instalación
Trajectory / Trayectoria	Grooves / Ranuras	Nozzle range / Gama boquillas (mm)	Pressure range / Gama presiones (bar)	Flow range / Gama caudales (l/hr)	Spacing max. / Distancia máx. (m)	Drop Type / Tipo bajante
Standard Angle / Ángulo estándar	10	2,8 - 10,3	0,41 - 1,03	196,3 - 4175,5	3	Rigid Drop / Bajante rígido

Nozzle Size / Tamaño boquilla		Throw Radius R / Radio alcance R (m)									Stream Height / Altura chorro S (m)		
		Installation Height / Altura instalación H=0,9m			Installation Height / Altura instalación H=1,8m			Installation Height / Altura instalación H=2,7m					
		Pressure / Presión (bar)			Pressure / Presión (bar)			Pressure / Presión (bar)			Pressure / Presión (bar)		
mm	1/128"	0,41	0,69	1,03	0,41	0,69	1,03	0,41	0,69	1,03	0,41	0,69	1,03
2,8	14	3,2	4,0	4,8	3,7	4,7	5,6	4,0	5,1	6,0	0,50	0,67	0,74
3,2	16	3,4	4,3	5,1	3,9	4,9	5,9	4,2	5,3	6,4	0,55	0,72	0,77
4,6	23	3,9	4,9	5,9	4,5	5,7	6,8	4,9	6,2	7,4	0,59	0,72	0,85
5,8	29	4,3	5,4	6,4	4,9	6,2	7,4	5,4	6,8	8,1	0,60	0,74	0,94
6,7	34	4,6	5,7	6,9	5,3	6,6	7,9	5,7	7,2	8,6	0,60	0,74	0,99
7,9	40	4,9	6,1	7,3	5,6	7,1	8,4	6,1	7,7	9,2	0,60	0,77	0,99
8,9	45	5,1	6,4	7,7	5,9	7,4	8,8	6,4	8,0	9,6	0,60	0,78	0,99
10,3	52	5,4	6,8	8,1	6,2	7,8	9,4	6,8	8,5	10,2	0,60	0,78	0,99

Para un óptimo rendimiento del Komet Precision Twister (KPT) es recomendable que, al instalar las tuberías de los bajantes, se use la máxima distancia sólo hasta el segundo tramo. Mantenga el Komet Precision Twister (KPT) fuera del dosel del cultivo, si la distancia sobrepasa 3 m. Instale el Komet Precision Twister (KPT) con una distancia del suelo al aspersor de por lo menos 1 m. Los datos de rendimiento, referentes a caudal y alcance en relación a la altura de instalación y tipo de deflector, que figuran en la tabla, tienen su origen en el modelo matemático, usado en el software del Komet Pivot Calculator. Los datos de rendimiento fueron obtenidos bajo condiciones de ensayo ideales y son base del modelo matemático. La presión se refiere a la presión a la boquilla. La altura del chorro se refiere a la altura a partir del deflector, hasta el punto más alto del perfil del chorro. Los datos referentes al caudal fueron obtenidos bajo condiciones de ensayo ideales y pueden ser afectados por un deficiente flujo hidráulico, turbulencias y otras condiciones.





Performance data / Datos de rendimiento



**komet | Precision Twister (KPT)** **STANDARD TRAJECTORY ANGLE**  
**TRAYECTORIA ÁNGULO ESTÁNDAR**

Deflector Specifications / Especificaciones del deflector		Operating Parameters / Parámetros operativos				Installation / Instalación
Trajectory / Trayectoria	Grooves / Ranuras	Nozzle range / Gama boquillas (1/128")	Pressure range / Gama presiones (psi)	Flow range / Gama caudales (gpm)	Spacing max. / Distancia máx. (ft)	Drop Type / Tipo bajante
Standard Angle / Ángulo estándar	10	10 - 52	6 - 20	0.44 - 21.33	20	Flex hose / Manguera flexible Poly Pipe / Tubo Polietileno

Nozzle Size / Tamaño boquilla (1/128")	Throw Diameter / Diámetro alcance D (ft)												Stream Height / Altura chorro S (in)			
	Installation Height / Altura instalación H=3ft				Installation Height / Altura instalación H=6ft				Installation Height / Altura instalación H=9ft				Pressure / Presión (psi)			
	Pressure / Presión (psi)				Pressure / Presión (psi)				Pressure / Presión (psi)				Pressure / Presión (psi)			
	6	10	15	20	6	10	15	20	6	10	15	20	6	10	15	20
10	27	33	39	42	33	39	45	48	37	43	49	52	22	31	34	44
16	31	38	43	46	37	44	49	52	41	48	53	57	26	33	36	45
23	35	41	47	50	41	47	53	56	45	51	57	60	27	33	39	48
29	37	43	49	52	43	49	55	58	47	53	59	62	28	34	43	49
34	38	44	50	53	44	50	56	59	48	54	60	63	28	34	46	49
40	38	44	50	53	43	50	55	59	48	54	60	63	28	35	46	49
45	37	43	49	52	43	49	54	58	47	53	59	62	28	36	46	49
52	34	40	46	49	40	46	52	55	44	50	56	59	28	36	46	49

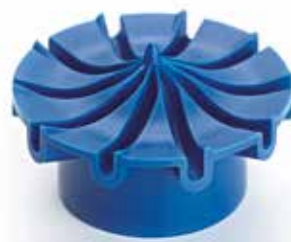

**komet | Precision Twister (KPT)** **LOW TRAJECTORY ANGLE**  
**TRAYECTORIA ÁNGULO BAJO**

Deflector Specifications / Especificaciones del deflector		Operating Parameters / Parámetros operativos				Installation / Instalación
Trajectory / Trayectoria	Grooves / Ranuras	Nozzle range / Gama boquillas (1/128")	Pressure range / Gama presiones (psi)	Flow range / Gama caudales (gpm)	Spacing max. / Distancia máx. (ft)	Drop Type / Tipo bajante
Low Angle / Ángulo bajo	10	10 - 52	6 - 20	0.44 - 21.33	18	Flex hose / Manguera flexible Poly Pipe / Tubo Polietileno

Nozzle Size / Tamaño boquilla (1/128")	Throw Diameter / Diámetro alcance D (ft)												Stream Height / Altura chorro S (in)			
	Installation Height / Altura instalación H=3ft				Installation Height / Altura instalación H=6ft				Installation Height / Altura instalación H=9ft				Pressure / Presión (psi)			
	Pressure / Presión (psi)				Pressure / Presión (psi)				Pressure / Presión (psi)				Pressure / Presión (psi)			
	6	10	15	20	6	10	15	20	6	10	15	20	6	10	15	20
10	25	31	36	39	31	38	43	46	36	42	48	51	13	18	25	28
16	28	35	40	43	35	41	47	50	40	46	52	55	13	19	25	28
23	32	38	43	46	38	45	50	53	43	50	55	58	13	19	26	28
29	33	39	45	48	40	46	52	54	45	51	57	59	13	19	26	28
34	34	40	45	48	40	47	52	55	45	52	57	60	13	19	26	30
40	33	39	45	48	40	46	52	54	45	51	57	59	13	20	26	30
45	32	38	44	47	39	45	50	53	44	50	55	58	13	20	26	30
52	29	35	41	44	36	42	48	50	41	47	52	55	13	20	26	30

For optimal performance of the Komet Precision Twister (KPT) when installed on drop pipes, it is recommended to use the maximum spacing up to the 2nd span only. Keep the Komet Precision Twister (KPT) out of the crop canopy when spacing exceeds 10 ft. Install the Komet Precision Twister (KPT) with a ground clearance of at least 3 ft. Performance data regarding flow and throw in relation to installation height and deflector type shown in the tables, originate from the mathematical model used in the Komet Pivot Calculator software. Performance data was obtained under ideal testing conditions and is the base for the mathematical model. Pressure refers to pressure at nozzle. Stream height is the height from the deflector to the highest droplets in the trajectory profile. Performance may be adversely affected by wind and other factors.

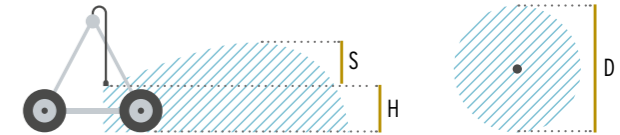

Performance data / Datos de rendimiento



**komet | Precision Twister (KPT)** **ULTRA-LOW TRAJECTORY ANGLE**  
**TRAYECTORIA ÁNGULO ULTRA-BAJO**

Deflector Specifications / Especificaciones del deflector		Operating Parameters / Parámetros operativos				Installation / Instalación
Trajectory / Trayectoria	Grooves / Ranuras	Nozzle range / Gama boquillas (1/128")	Pressure range / Gama presiones (psi)	Flow range / Gama caudales (gpm)	Spacing max. / Distancia máx. (ft)	Drop Type / Tipo bajante
Ultra-Low Angle / Ángulo ultra-bajo	10	10 - 52	6-20	0.44 - 21.33	15	Flex hose / Manguera flexible Poly Pipe / Tubo Polietileno

Nozzle Size / Tamaño boquilla (1/128")	Throw Diameter / Diámetro alcance D (ft)												Stream Height / Altura chorro S (in)			
	Installation Height / Altura instalación H=3ft				Installation Height / Altura instalación H=6ft				Installation Height / Altura instalación H=9ft				Pressure / Presión (psi)			
	Pressure / Presión (psi)				Pressure / Presión (psi)				Pressure / Presión (psi)				Pressure / Presión (psi)			
	6	10	15	20	6	10	15	20	6	10	15	20	6	10	15	20
10	21	27	32	35	30	35	41	44	35	41	46	49	5	6	10	11
16	25	30	36	39	33	39	44	47	39	45	50	53	4	7	7	10
23	28	33	39	42	36	42	47	50	42	48	53	56	4	7	7	12
29	29	35	40	43	37	43	49	52	43	49	54	57	4	7	8	13
34	29	35	40	43	38	44	49	52	44	49	55	58	4	7	8	15
40	29	34	40	43	37	43	48	51	43	49	54	57	4	7	8	15
45	27	33	38	42	36	42	47	50	42	48	53	56	4	7	8	15
52	24	30	35	39	33	39	44	47	39	45	50	53	4	7	8	15

Para un óptimo rendimiento del Komet Precision Twister (KPT) es recomendable que, al instalar las tuberías de los bajantes, se use la máxima distancia sólo hasta el segundo tramo. Mantenga el Komet Precision Twister (KPT) fuera del dosel del cultivo, si la distancia sobrepasa 10 ft. Instale el Komet Precision Twister (KPT) con una distancia del suelo al aspersor de por lo menos 3 ft. Los datos de rendimiento, referentes a caudal y alcance en relación a la altura de instalación y tipo de deflector, que figuran en la tabla, tienen su origen en el modelo matemático, usado en el software del Komet Pivot Calculator. Los datos de rendimiento fueron obtenidos bajo condiciones de ensayo ideales y son base del modelo matemático. La presión se refiere a la presión a la boquilla. La altura del chorro se refiere a la altura a partir del deflector, hasta el punto más alto del perfil del chorro. Los datos referentes al caudal fueron obtenidos bajo condiciones de ensayo ideales y pueden ser afectados por un deficiente flujo hidráulico, turbulencias y otras condiciones.



Performance data / Datos de rendimiento

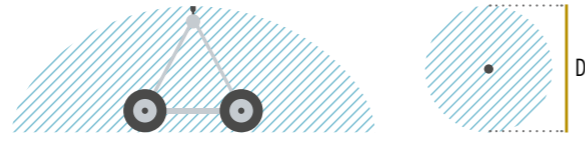

**komet | Precision Twister (KPT) Peak** **LOW PROFILE TRAJECTORY**  
**TRAYECTORIA DE BAJO PERFIL**

Deflector Specifications / Especificaciones del deflector		Operating Parameters / Parámetros operativos				Installation / Instalación
Trajectory / Trayectoria	Grooves / Ranuras	Nozzle range / Gama boquillas (1/128")	Pressure range / Gama presiones (psi)	Flow range / Gama caudales (gpm)	Spacing max. / Distancia máx. (ft)	Top of pipe / Encima del tubo
Low Profile Trajectory / Trayectoria de bajo perfil	10	10 - 52	6-20	0.44 - 21.33	20	KPT-Link connector required / Conector KPT-Link necesario

Nozzle Size / Tamaño boquilla (1/128")	Throw Diameter / Diámetro alcance D (ft)								Stream Height / Altura chorro S (in)			
	Installation Height / Altura instalación H=7ft				Installation Height / Altura instalación H=13ft				Pressure / Presión (psi)			
	Pressure / Presión (psi)				Pressure / Presión (psi)							
	6	10	15	20	6	10	15	20	6	10	15	20
10	32	38	44	49	39	46	52	56				
16	34	40	46	51	41	47	53	58				
23	35	41	47	52	42	48	55	59				
29	36	42	48	53	43	49	56	60				
34	37	43	49	54	44	50	56	61				
40	38	44	50	55	45	51	57	62				
45	38	44	50	55	45	52	58	62				
52	39	45	51	56	46	52	58	63				

LOW PROFILE  
BAJO PERFIL

For optimal performance of the Komet Precision Twister (KPT) when installed on drop pipes, it is recommended to use the maximum spacing up to the 2nd span only. Keep the Komet Precision Twister (KPT) out of the crop canopy when spacing exceeds 10 ft. Install the Komet Precision Twister (KPT) with a ground clearance of at least 3 ft. Performance data regarding flow and throw in relation to installation height and deflector type shown in the tables, originate from the mathematical model used in the Komet Pivot Calculator software. Performance data was obtained under ideal testing conditions and is the base for the mathematical model. Pressure refers to pressure at nozzle. Stream height is the height from the deflector to the highest droplets in the trajectory profile. Performance may be adversely affected by wind and other factors.

Performance data / Datos de rendimiento

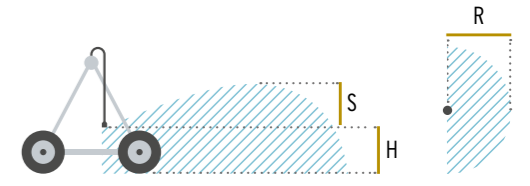

**komet | Precision Twister (KPT) PC180** **PART CIRCLE**  
**CÍRCULO PARCIAL**

Deflector Specifications / Especificaciones del deflector		Operating Parameters / Parámetros operativos				Installation / Instalación
Trajectory / Trayectoria	Grooves / Ranuras	Nozzle range / Gama boquillas (1/128")	Pressure range / Gama presiones (psi)	Flow range / Gama caudales (gpm)	Spacing max. / Distancia máx. (ft)	Drop Type / Tipo bajante
Standard Angle / Ángulo estándar	10	14 - 52	6 - 15	0.86 - 18.38	10	Rigid Drop / Bajante rígido

Nozzle Size / Tamaño boquilla (1/128")	Throw Radius R / Radio alcance R (ft)									Stream Height / Altura chorro S (in)		
	Installation Height / Altura instalación H=3ft			Installation Height / Altura instalación H=6ft			Installation Height / Altura instalación H=9ft			Pressure / Presión (bar)		
	Pressure / Presión (bar)			Pressure / Presión (bar)			Pressure / Presión (bar)					
	6	10	15	6	10	15	6	10	15	6	10	15
14	10,6	13,3	15,9	12,2	15,3	18,3	13,2	16,6	19,9	20	26	29
16	11,2	14,0	16,7	12,8	16,1	19,3	14,0	17,5	20,9	22	28	30
23	12,9	16,2	19,3	14,8	18,6	22,3	16,1	20,2	24,2	23	28	33
29	14,1	17,7	21,2	16,3	20,4	24,4	17,7	22,1	26,5	24	29	37
34	15,0	18,9	22,6	17,3	21,7	26,0	18,8	23,6	28,2	24	29	39
40	16,0	20,1	24,1	18,5	23,2	27,7	20,1	25,2	30,1	24	30	39
45	16,8	21,1	25,2	19,4	24,3	29,0	21,0	26,4	31,5	24	31	39
52	17,8	22,3	26,7	20,5	25,7	30,7	22,3	27,9	33,4	24	31	39

Para un óptimo rendimiento del Komet Precision Twister (KPT) es recomendable que, al instalar las tuberías de los bajantes, se use la máxima distancia sólo hasta el segundo tramo. Mantenga el Komet Precision Twister (KPT) fuera del dosel del cultivo, si la distancia sobrepasa 10 ft. Instale el Komet Precision Twister (KPT) con una distancia del suelo al aspersor de por lo menos 3 ft. Los datos de rendimiento, referentes a caudal y alcance en relación a la altura de instalación y tipo de deflector, que figuran en la tabla, tienen su origen en el modelo matemático, usado en el software del Komet Pivot Calculator. Los datos de rendimiento fueron obtenidos bajo condiciones de ensayo ideales y son base del modelo matemático. La presión se refiere a la presión a la boquilla. La altura del chorro se refiere a la altura a partir del deflector, hasta el punto más alto del perfil del chorro. Los datos referentes al caudal fueron obtenidos bajo condiciones de ensayo ideales y pueden ser afectados por un deficiente flujo hidráulico, turbulencias y otras condiciones.



# komet | Precision Spray (KPS)

## Key features / Características clave



Komet Rapid Fit Deflector System  
Komet Rapid Fit sistema de deflectores

## Komet Rapid Fit Deflector System Komet Rapid Fit sistema de deflectores



- 1.** Pull to remove the deflector  
Tire, para extraer el deflector
- 2.** Turn it over for the 57° upstream corn chemigation deflector or install an additional mini deflector  
Gírelo para utilizar el deflector a 57° para la quimigación de maíz, o instale un deflector mini adicional.
- 3.** Re-insert deflector, push to install and click to secure  
Vuelva a colocar el deflector y presione hasta el clic para fijarlo.



Available Models LESA  
Modelos disponibles LESA

## Komet Precision Spray (KPS) 360



**Blue Deflector CC 33**  
Deflector azul CC 33

Concave, medium grooves for most applications. Good throw. Cóncavo, ranuras medianas, para la mayoría de aplicaciones. Buen alcance.



**Black Deflector FL 33**  
Deflector negro FL 33

Flat, medium grooves, for most applications. Good resistance to wind. Plano, ranuras medianas, para la mayoría de aplicaciones. Buena resistencia al viento.



**Grey Deflector FL 24**  
Deflector gris FL 24

Flat, deep grooves, bigger droplets. Best resistance to wind. Plano, ranuras profundas, gotas más grandes. Mayor resistencia al viento.



**Yellow Deflector FL 30**  
Deflector amarillo FL 30

Flat, fine grooves, fine droplets for sensitive crops. Plano, ranuras finas, gotas finas para cultivos sensibles.



**Mini Turquoise Deflector FL**  
Mini Deflector turquesa FL

Smooth, for germination and very sensitive crops. Liso, para germinación y cultivos muy sensibles.



**Mini Black Deflector FL 24**  
Mini Deflector negro FL 24

Flat, medium grooves. Plano, ranuras medianas.

Available Models LEPA  
Modelos disponibles LEPA

## Komet Precision Spray (KPS) Vertical Bubbler

The Komet Precision Spray (KPS) Vertical Bubbler is a LEPA device used for in-furrow water application. Crops need to be planted in circles. El Komet Precision Spray (KPS) Vertical Bubbler es un dispositivo LEPA utilizado para riego en surcos. La plantación debe ser circular.



**Vertical Bubbler**  
Reverse deflector  
CC 33 Blue

**Vertical Bubbler**  
Reverso deflector  
Azul CC 33



**Vertical Bubbler**  
Reverse deflector  
FL 33 Black

**Vertical Bubbler**  
Reverso deflector  
Negro FL 33



**Vertical Bubbler**  
Reverse deflector  
FL 24 Grey

**Vertical Bubbler**  
Reverso deflector  
Gris FL 24



**Vertical Bubbler**  
Reverse deflector  
FL 30 Yellow

**Vertical Bubbler**  
Reverso deflector  
Amarillo FL 30

## Komet Precision Spray (KPS) Dual



**Blue Deflector w/Hole CC 33**  
Deflector azul con agujero CC 33

The combination of two deflectors helps to deal with higher flows by dividing the distribution of the water into two separate deflectors. This allows the optimal separation of streams even with higher flows.

La combinación de dos deflectores permite manejar caudales mayores, repartiendo la distribución del agua entre dos deflectores separados permitiendo así una óptima separación de los chorros, también con caudales mayores.



**Black Deflector FL 33**  
Deflector negro FL 33

Flat, medium grooves, for most applications. Good resistance to wind.

Plano, ranuras medianas, para la mayoría de aplicaciones. Buena resistencia al viento.

## Komet Precision Spray (KPS) Wide Bubbler 60"

The Komet Precision Spray (KPS) Wide Bubbler 60" is a LEPA device used for precision water application close to the soil. Suitable for any planting method. El Komet Precision Spray (KPS) Wide Bubbler 60" es un dispositivo LEPA utilizado para una aplicación precisa cerca del suelo. Apta para todos los métodos de plantación.



**Wide Bubbler 60"**  
Reverse deflector  
FL 33 Brown

**Wide Bubbler 60"**  
Reverso deflector  
Marrón FL 33

## Komet Precision Spray (KPS) 180 Part Circle



**Blue Deflector CC 15**  
Deflector azul CC 15

Part circle 180° deflector helps to prevent excessive watering of the wheel tracks near the towers. Install on rigid drops.

Deflector de círculo parcial 180°, para ruedas secas cerca de las torres. Tiene 15 chorros individuales. Instalar en bajantes rígidos.





Performance data / Datos de rendimiento



**BLUE DEFLECTOR CC33**  
DEFLECTOR AZUL CC33

**komet** | Precision Spray (KPS) 360

Deflector Specifications / Especificaciones deflector				Operating Parameters / Parámetros operativos				Installation / Instalación
Trajectory / Trayectoria	Grooves / Ranuras	Type / Tipo	Coverage / Cobertura	Nozzle range / Gama boquillas (mm)	Pressure range / Gama presiones (bar)	Flow range / Gama caudales (l/hr)	Spacing max. / Distancia máx. (m)	Drop Type / Tipo bajante
Concave / Cóncava	33	Medium / Mediano	360°	1,6 - 10,3	0,41 - 2,1	64,7 - 5973,5	3,4	All Types / Todos los tipos

Nozzle Size / Tamaño boquilla		Throw Diameter / Diámetro alcance D (m)												Stream Height / Altura chorro S (m)			
		Installation Height / Altura instalación H=0,9m				Installation Height / Altura instalación H=1,8m				Installation Height / Altura instalación H=2,7m							
		Pressure / Presión (bar)		Pressure / Presión (bar)		Pressure / Presión (bar)		Pressure / Presión (bar)		Pressure / Presión (bar)		Pressure / Presión (bar)					
mm	1/128"	0,41	0,69	1,03	1,38	0,41	0,69	1,03	1,38	0,41	0,69	1,03	1,38	0,41	0,69	1,03	1,38
1,6	8	4,8	6,0	7,0	7,9	5,9	7,3	8,6	9,7	6,6	8,2	9,7	10,9	0,02	0,04	0,05	0,06
3,2	16	6,1	7,5	8,9	10,0	7,4	9,2	10,9	12,3	8,4	10,4	12,2	13,8	0,03	0,08	0,09	0,09
4,6	23	6,8	8,5	10,0	11,3	8,4	10,4	12,3	13,8	9,4	11,7	13,8	15,6	0,04	0,10	0,12	0,15
5,8	29	7,4	9,2	10,8	12,2	9,1	11,2	13,3	15,0	10,2	12,6	14,9	16,8	0,06	0,12	0,13	0,16
6,7	34	7,8	9,7	11,4	12,9	9,6	11,8	14,0	15,8	10,8	13,3	15,7	17,8	0,07	0,13	0,15	0,19
7,9	40	8,2	10,2	12,1	13,6	10,1	12,5	14,8	16,7	11,4	14,1	16,6	18,8	0,08	0,15	0,17	0,20
8,9	45	8,6	10,6	12,5	14,2	10,5	13,0	15,4	17,3	11,8	14,7	17,3	19,5	0,08	0,15	0,18	0,23
10,3	52	9,0	11,2	13,2	14,9	11,0	13,7	16,1	18,2	12,4	15,4	18,2	20,5	0,09	0,18	0,20	0,25



**BLACK DEFLECTOR FL33**  
DEFLECTOR NEGRO FL33

**komet** | Precision Spray (KPS) 360

Deflector Specifications / Especificaciones deflector				Operating Parameters / Parámetros operativos				Installation / Instalación
Trajectory / Trayectoria	Grooves / Ranuras	Type / Tipo	Coverage / Cobertura	Nozzle range / Gama boquillas (mm)	Pressure range / Gama presiones (bar)	Flow range / Gama caudales (l/hr)	Spacing max. / Distancia máx. (m)	Drop Type / Tipo bajante
Flat / Plana	33	Medium / Mediano	360°	1,6 - 10,3	0,41 - 2,1	64,7 - 5973,5	3,4	All Types / Todos los tipos

Nozzle Size / Tamaño boquilla		Throw Diameter / Diámetro alcance D (m)												Stream Height / Altura chorro S (m)			
		Installation Height / Altura instalación H=0,9m				Installation Height / Altura instalación H=1,8m				Installation Height / Altura instalación H=2,7m							
		Pressure / Presión (bar)		Pressure / Presión (bar)		Pressure / Presión (bar)		Pressure / Presión (bar)		Pressure / Presión (bar)		Pressure / Presión (bar)					
mm	1/128"	0,41	0,69	1,03	1,38	0,41	0,69	1,03	1,38	0,41	0,69	1,03	1,38	0,41	0,69	1,03	1,38
1,6	8	5,3	6,5	7,7	8,6	6,6	8,2	9,6	10,8	7,6	9,3	10,9	12,3				
3,2	16	5,8	7,2	8,4	9,5	7,3	9,0	10,5	11,8	8,3	10,2	12,0	13,5				
4,6	23	6,5	8,1	9,5	10,6	8,2	10,1	11,8	13,3	9,3	11,5	13,5	15,2				
5,8	29	7,1	8,7	10,2	11,4	8,8	10,9	12,8	14,3	10,1	12,4	14,6	16,4				
6,7	34	7,4	9,1	10,7	12,1	9,3	11,4	13,4	15,1	10,6	13,1	15,3	17,2				
7,9	40	7,8	9,6	11,3	12,7	9,8	12,1	14,2	15,9	11,2	13,8	16,1	18,1				
8,9	45	8,1	10,0	11,7	13,2	10,2	12,5	14,7	16,5	11,6	14,3	16,8	18,8				
10,3	52	8,4	10,3	12,1	13,6	10,5	12,9	15,1	17,0	11,9	14,7	17,2	19,4				

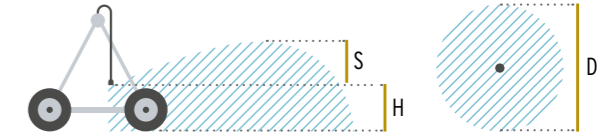

Performance data / Datos de rendimiento



**GREY DEFLECTOR FL24**  
DEFLECTOR GRIS FL24

**komet** | Precision Spray (KPS) 360

Deflector Specifications / Especificaciones deflector				Operating Parameters / Parámetros operativos				Installation / Instalación
Trajectory / Trayectoria	Grooves / Ranuras	Type / Tipo	Coverage / Cobertura	Nozzle range / Gama boquillas (mm)	Pressure range / Gama presiones (bar)	Flow range / Gama caudales (l/hr)	Spacing max. / Distancia máx. (m)	Drop Type / Tipo bajante
Flat / Plana	24	Deep / Profundo	360°	1,6 - 10,3	0,41 - 2,1	64,7 - 5973,5	3,4	All Types / Todos los tipos

Nozzle Size / Tamaño boquilla		Throw Diameter / Diámetro alcance D (m)												Stream Height / Altura chorro S (m)			
		Installation Height / Altura instalación H=0,9m				Installation Height / Altura instalación H=1,8m				Installation Height / Altura instalación H=2,7m							
		Pressure / Presión (bar)		Pressure / Presión (bar)		Pressure / Presión (bar)		Pressure / Presión (bar)		Pressure / Presión (bar)		Pressure / Presión (bar)					
mm	1/128"	0,41	0,69	1,03	1,38	0,41	0,69	1,03	1,38	0,41	0,69	1,03	1,38	0,41	0,69	1,03	1,38
1,6	8	5,2	6,5	7,7	8,8	6,7	8,4	9,9	11,2	7,7	9,7	11,5	13,0				
3,2	16	6,1	7,6	9,0	10,2	7,8	9,7	11,5	13,0	9,0	11,2	13,3	15,1				
4,6	23	6,6	8,2	9,7	11,0	8,4	10,5	12,4	14,1	9,7	12,1	14,4	16,3				
5,8	29	6,9	8,6	10,2	11,6	8,8	11,0	13,1	14,8	10,2	12,7	15,1	17,1				
6,7	34	7,1	8,9	10,6	12,0	9,1	11,4	13,5	15,3	10,6	13,2	15,6	17,7				
7,9	40	7,4	9,2	10,9	12,4	9,5	11,8	14,0	15,9	10,9	13,6	16,2	18,3				
8,9	45	7,6	9,5	11,2	12,7	9,7	12,1	14,4	16,3	11,2	14,0	16,6	18,8				
10,3	52	7,8	9,8	11,6	13,1	10,0	12,5	14,8	16,8	11,6	14,4	17,1	19,4				



**YELLOW DEFLECTOR FL30**  
DEFLECTOR AMARILLO FL30

**komet** | Precision Spray (KPS) 360

Deflector Specifications / Especificaciones deflector				Operating Parameters / Parámetros operativos				Installation / Instalación
Trajectory / Trayectoria	Grooves / Ranuras	Type / Tipo	Coverage / Cobertura	Nozzle range / Gama boquillas (mm)	Pressure range / Gama presiones (bar)	Flow range / Gama caudales (l/hr)	Spacing max. / Distancia máx. (m)	Drop Type / Tipo bajante
Flat / Plana	30	Fine / Fino	360°	1,6 - 10,3	0,41 - 2,1	64,7 - 5973,5	3,4	All Types / Todos los tipos

Nozzle Size / Tamaño boquilla		Throw Diameter / Diámetro alcance D (m)												Stream Height / Altura chorro S (m)			
		Installation Height / Altura instalación H=0,9m				Installation Height / Altura instalación H=1,8m				Installation Height / Altura instalación H=2,7m							
		Pressure / Presión (bar)		Pressure / Presión (bar)		Pressure / Presión (bar)		Pressure / Presión (bar)		Pressure / Presión (bar)		Pressure / Presión (bar)					
mm	1/128"	0,41	0,69	1,03	1,38	0,41	0,69	1,03	1,38	0,41	0,69	1,03	1,38	0,41	0,69	1,03	1,38
1,6	8	4,7	5,7	6,7	7,6	6,0	7,3	8,6	9,7	6,9	8,5	9,9	11,1				
3,2	16	5,6	6,9	8,1	9,1	7,1	8,8	10,3	11,6	8,2	10,1	11,9	13,4				
4,6	23	6,2	7,6	8,9	10,0	7,9	9,7	11,3	12,7	9,1	11,2	13,1	14,7				
5,8	29	6,5	8,0	9,4	10,6	8,3	10,3	12,0	13,5	9,6	11,9	13,9	15,6				
6,7	34	6,8	8,4	9,8	11,0	8,7	10,7	12,6	14,1	10,0	12,4	14,5	16,3				
7,9	40	7,1	8,7	10,3	11,5	9,1	11,2	13,1	14,7	10,5	12,9	15,1	17,0				
8,9	45	7,3	9,0	10,6	11,9	9,4	11,5	13,5	15,2	10,8	13,3	15,6	17,5				
10,3	52	7,6	9,4	11,0	12,3	9,7	12,0	14,0	15,8	11,2	13,8	16,2	18,2				





Performance data / Datos de rendimiento



**MINI BLACK DEFLECTOR FL24**  
**MINI DEFLECTOR NEGRO FL24**

**komet | Precision Spray (KPS) 360**

Deflector Specifications / Especificaciones deflector				Operating Parameters / Parámetros operativos				Installation / Instalación
Trajectory / Trayectoria	Grooves / Ranuras	Type / Tipo	Coverage / Cobertura	Nozzle range / Gama boquillas (mm)	Pressure range / Gama presiones (bar)	Flow range / Gama caudales (l/hr)	Spacing max. / Distancia máx. (m)	Drop Type / Tipo bajante
Flat / Plana	24	Medium / Mediano	360°	1,6 - 3,6	0,41 - 2,1	64,7 - 742,2	3,4	All Types / Todos los tipos

Nozzle Size / Tamaño boquilla		Throw Diameter / Diámetro alcance D (m)												Stream Height / Altura chorro S (m)			
		Installation Height / Altura instalación H=0,9m				Installation Height / Altura instalación H=1,8m				Installation Height / Altura instalación H=2,7m							
		mm	1/128"	0,41	0,69	1,03	1,38	0,41	0,69	1,03	1,38	0,41	0,69	1,03	1,38	0,41	0,69
1,6	8	5,6	6,8	8,0	9,0	7,0	8,6	10,1	11,3	8,0	9,8	11,5	12,9	FLAT PLANA			
3,6	18	6,8	8,3	9,7	10,9	8,5	10,5	12,2	13,7	9,7	12,0	14,0	15,7	FLAT PLANA			

**komet | Precision Spray (KPS) 360**



**MINI TURQUOISE DEFLECTOR FL**  
**MINI DEFLECTOR TURQUESA FL**

Deflector Specifications / Especificaciones deflector				Operating Parameters / Parámetros operativos				Installation / Instalación
Trajectory / Trayectoria	Grooves / Ranuras	Type / Tipo	Coverage / Cobertura	Nozzle range / Gama boquillas (mm)	Pressure range / Gama presiones (bar)	Flow range / Gama caudales (l/hr)	Spacing max. / Distancia máx. (m)	Drop Type / Tipo bajante
Flat / Plana	0	Smooth / Liso	360°	1,6 - 10,3	0,41 - 2,1	64,7 - 5973,5	3,4	All Types / Todos los tipos

Nozzle Size / Tamaño boquilla		Throw Diameter / Diámetro alcance D (m)												Stream Height / Altura chorro S (m)			
		Installation Height / Altura instalación H=0,9m				Installation Height / Altura instalación H=1,8m				Installation Height / Altura instalación H=2,7m							
		mm	1/128"	0,41	0,69	1,03	1,38	0,41	0,69	1,03	1,38	0,41	0,69	1,03	1,38	0,41	0,69
1,6	8	4,4	4,7	5,0	5,2	5,3	5,8	6,1	6,4	6,0	6,5	6,9	7,2	FLAT PLANA			
3,2	16	5,3	5,7	6,1	6,3	6,5	7,0	7,4	7,7	7,3	7,9	8,3	8,7	FLAT PLANA			
4,6	23	5,9	6,3	6,7	7,0	7,2	7,7	8,2	8,6	8,1	8,7	9,2	9,6	FLAT PLANA			
5,8	29	6,3	6,8	7,2	7,5	7,7	8,3	8,8	9,1	8,6	9,3	9,9	10,3	FLAT PLANA			
6,7	34	6,6	7,1	7,5	7,8	8,0	8,7	9,2	9,6	9,0	9,7	10,3	10,8	FLAT PLANA			
7,9	40	6,9	7,4	7,8	8,2	8,4	9,1	9,6	10,0	9,5	10,2	10,8	11,3	FLAT PLANA			
8,9	45	7,1	7,7	8,1	8,5	8,7	9,4	9,9	10,4	9,8	10,5	11,2	11,6	FLAT PLANA			
10,3	52	7,4	8,0	8,5	8,8	9,0	9,8	10,3	10,8	10,2	11,0	11,6	12,1	FLAT PLANA			

For optimal performance of the Komet Precision Spray (KPS) when installed on drop pipes, it is recommended to use the maximum spacing up to the 2nd span only. Keep the Komet Precision Spray (KPS) out of the crop canopy when spacing exceeds 3 m. Install the Komet Precision Spray (KPS) with a ground clearance of at least 1 m. Performance data regarding flow and throw in relation to installation height and deflector type shown in the tables, originate from the mathematical model used in the Komet Pivot Calculator software. Performance data was obtained under ideal testing conditions and is the base for the mathematical model. Pressure refers to pressure at nozzle. Stream height is the height from the deflector to the highest droplets in the trajectory profile. Performance may be adversely affected by wind and other factors.

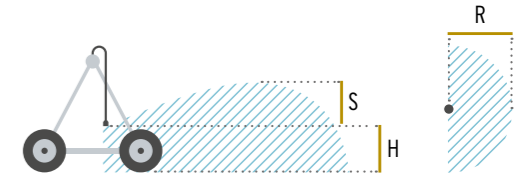

Performance data / Datos de rendimiento



**BLUE DEFLECTOR CC15 - PC180**  
**DEFLECTOR AZUL CC15 - PC180**

**komet | Precision Spray (KPS) 180 Part Circle**

Deflector Specifications / Especificaciones deflector				Operating Parameters / Parámetros operativos				Installation / Instalación
Trajectory / Trayectoria	Grooves / Ranuras	Type / Tipo	Coverage / Cobertura	Nozzle range / Gama boquillas (mm)	Pressure range / Gama presiones (bar)	Flow range / Gama caudales (l/hr)	Spacing max. / Distancia máx. (m)	Drop Type / Tipo bajante
Concave / Cóncava	15	Medium / Mediano	180°	1,6 - 7,9	0,41 - 2,1	64,7 - 3529,1	3,4	Rigid drops only / Bajantes rígidos

Nozzle Size / Tamaño boquilla		Throw Radius / Radio alcance R (m)												Stream Height / Altura chorro S (m)			
		Installation Height / Altura instalación H=0,9m				Installation Height / Altura instalación H=1,8m				Installation Height / Altura instalación H=2,7m							
		mm	1/128"	0,41	0,69	1,03	1,38	0,41	0,69	1,03	1,38	0,41	0,69	1,03	1,38	0,41	0,69
1,6	8	2,4	3,0	3,5	4,0	2,9	3,6	4,3	4,9	3,3	4,1	4,8	5,5	0,02	0,04	0,05	0,06
3,2	16	3,0	3,8	4,4	5,0	3,7	4,6	5,4	6,1	4,2	5,2	6,1	6,9	0,03	0,08	0,09	0,09
4,6	23	3,4	4,2	5,0	5,7	4,2	5,2	6,1	6,9	4,7	5,9	6,9	7,8	0,04	0,10	0,12	0,15
5,8	29	3,7	4,6	5,4	6,1	4,5	5,6	6,6	7,5	5,1	6,3	7,5	8,4	0,06	0,12	0,13	0,16
6,7	34	3,9	4,8	5,7	6,4	4,8	5,9	7,0	7,9	5,4	6,7	7,9	8,9	0,07	0,13	0,15	0,19
7,9	40	4,0	5,0	5,9	6,6	4,9	6,1	7,2	8,1	5,5	6,9	8,1	9,1	0,08	0,15	0,17	0,20

Para un óptimo rendimiento del Komet Precision Spray (KPS) es recomendable que, al instalar las tuberías de los bajantes, se use la máxima distancia sólo hasta el segundo tramo. Mantenga el Komet Precision Spray (KPS) fuera del dosel del cultivo, si la distancia sobrepasa 3 m. Instale el Komet Precision Spray (KPS) con una distancia del suelo al aspersor de por lo menos 1 m. Los datos de rendimiento, referentes a caudal y alcance en relación a la altura de instalación y tipo de deflector, que figuran en la tabla, tienen su origen en el modelo matemático, usado en el software del Komet Pivot Calculator. Los datos de rendimiento fueron obtenidos bajo condiciones de ensayo ideales y son base del modelo matemático. La presión se refiere a la presión a la boquilla. La altura del chorro se refiere a la altura a partir del deflector, hasta el punto más alto del perfil del chorro. Los datos referentes al caudal fueron obtenidos bajo condiciones de ensayo ideales y pueden ser afectados por un deficiente flujo hidráulico, turbulencias y otras condiciones.





Performance data / Datos de rendimiento



**BLUE DEFLECTOR CC33**  
DEFLECTOR AZUL CC33

### komet | Precision Spray (KPS) Dual

Deflector Specifications / Especificaciones deflector				Operating Parameters / Parámetros operativos				Installation / Instalación	
Trajectory / Trayectoria	Grooves / Ranuras	Type / Tipo	Coverage / Cobertura	Nozzle range / Gama boquillas (mm)	Pressure range / Gama presiones (bar)	Flow range / Gama caudales (l/hr)	Spacing max. / Distancia máx. (m)	Drop Type / Tipo bajante	
Concave / Cóncava	33	Medium / Mediano	360°	1,6 - 5,8	0,41 - 2,1	64,7 - 1876,8	3,4	All Types / Todos los tipos	

Nozzle Size / Tamaño boquilla	mm	1/128"	Throw Diameter / Diámetro alcance D (m)								Stream Height / Altura chorro S (m)			
			Installation Height / Altura instalación H=0,9m				Installation Height / Altura instalación H=1,8m				Pressure / Presión (bar)			
			0,41	0,69	1,03	1,38	0,41	0,69	1,03	1,38	0,41	0,69	1,03	1,38
1,6	8	4,8	6,0	7,0	7,9	5,9	7,3	8,6	9,7	0,02	0,04	0,05	0,06	
3,2	16	6,1	7,5	8,9	10,0	7,4	9,2	10,9	12,3	0,03	0,08	0,09	0,09	
4,6	23	6,8	8,5	10,0	11,3	8,4	10,4	12,3	13,8	0,04	0,10	0,12	0,15	
5,8	29	7,4	9,2	10,8	12,2	9,1	11,2	13,3	15,0	0,06	0,12	0,13	0,16	



**BLUE DEFLECTOR W/HOLE CC33**  
DEFLECTOR AZUL CON AGUJERO CC33

**BLACK DEFLECTOR FL33**  
DEFLECTOR NEGRO FL33

### komet | Precision Spray (KPS) Dual

Deflector Specifications / Especificaciones deflector				Operating Parameters / Parámetros operativos				Installation / Instalación	
Trajectory / Trayectoria	Grooves / Ranuras	Type / Tipo	Coverage / Cobertura	Nozzle range / Gama boquillas (mm)	Pressure range / Gama presiones (bar)	Flow range / Gama caudales (l/hr)	Spacing max. / Distancia máx. (m)	Drop Type / Tipo bajante	
Flat / Plana	33	Medium / Mediano	360°	6,0 - 10,3	0,41 - 2,1	890,3 - 5973,5	3,4	All Types / Todos los tipos	

Nozzle Size / Tamaño boquilla	mm	1/128"	Throw Diameter / Diámetro alcance D (m)								Stream Height / Altura chorro S (m)			
			Installation Height / Altura instalación H=0,9m				Installation Height / Altura instalación H=1,8m				Pressure / Presión (bar)			
			0,41	0,69	1,03	1,38	0,41	0,69	1,03	1,38	0,41	0,69	1,03	1,38
6,0	30	7,00	8,90	10,00	11,30	8,20	10,20	12,40	13,20	0,06	0,12	0,13	0,16	
6,7	34	7,20	9,20	10,20	11,60	8,80	10,60	12,80	13,60	0,07	0,13	0,15	0,19	
7,9	40	7,80	9,90	11,40	12,20	9,40	11,80	13,40	14,00	0,08	0,14	0,17	0,20	
8,9	45	8,40	10,70	12,10	13,50	10,00	12,20	14,00	15,20	0,08	0,15	0,18	0,23	
10,3	52	8,90	11,80	12,50	14,00	11,00	12,80	14,20	15,60	0,09	0,18	0,20	0,25	

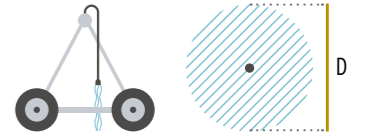

Performance data / Datos de rendimiento



**BROWN DEFLECTOR WB60**  
DEFLECTOR MARRÓN WB60

### komet | Precision Spray (KPS) Vertical Bubbler

Deflector Specifications / Especificaciones deflector			Operating Parameters / Parámetros operativos				Installation / Instalación	
Trajectory / Trayectoria	Coverage / Cobertura	Nozzle range / Gama boquillas (mm)	Pressure range / Gama presiones (bar)	Flow range / Gama caudales (l/hr)	Spacing max. / Distancia máx. (m)	Installation height / Altura de instalación (m)	Drop Type / Tipo bajante	
Vertical / Vertical	Localized / Localizado	1,6 - 8,9	0,41 - 2,1	64,7 - 4419,2	0,7 - 1,5 Furrow Dependent / Surco Dependiente	0,2 - 0,45	All Types / Todos los tipos	

The reverse side of the Vertical Bubbler deflector corresponds with the Komet Precision Spray (KPS) deflector 360 in the respective colour. For the performance data please refer to the tables for Komet Precision Spray (KPS) deflectors 360.  
El reverso del deflector Vertical Bubbler se corresponde con el deflector 360 de Komet Precision Spray (KPS) en el color respectivo. Los datos técnicos se encuentran en las tablas de deflectores Komet Precision Spray (KPS) 360.

### komet | Precision Spray (KPS) Wide Bubbler 60"

Deflector Specifications / Especificaciones deflector			Operating Parameters / Parámetros operativos				Installation / Instalación	
Trajectory / Trayectoria	Coverage / Cobertura	Nozzle range / Gama boquillas (mm)	Pressure range / Gama presiones (bar)	Flow range / Gama caudales (l/hr)	Spacing max. / Distancia máx. (m)	Installation height / Altura de instalación (m)	Drop Type / Tipo bajante	
Dome / Dome	360°	1,8 - 6,0	0,41 - 2,1	81,7 - 2008,2	1,5	0,45 - 0,75	All Types / Todos los tipos	

Nozzle Size / Tamaño boquilla	mm	1/128"	Throw Diameter / Diámetro alcance D (m)											
			Installation Height / Altura instalación H=0,45m				Installation Height / Altura instalación H=0,6m				Installation Height / Altura instalación H=0,75m			
			0,41	0,69	1,03	1,38	0,41	0,69	1,03	1,38	0,41	0,69	1,03	1,38
1,8	9	1,00	1,30	1,80	1,90	1,10	1,45	2,00	2,15	1,20	1,60	2,20	2,40	
2,0	10	1,40	1,50	1,90	2,00	1,45	1,75	2,15	2,30	1,50	2,00	2,40	2,60	
2,2	11	1,50	1,60	2,00	2,20	1,60	1,85	2,25	2,45	1,70	2,10	2,50	2,70	
2,4	12	1,60	1,80	2,20	2,30	1,75	2,00	2,40	2,55	1,90	2,20	2,60	2,80	
2,8	14	1,80	1,90	2,30	2,50	1,90	2,20	2,60	2,80	2,00	2,50	2,90	3,10	
3,6	18	2,00	2,10	2,40	2,70	2,20	2,45	2,80	3,10	2,40	2,80	3,20	3,50	
4,4	22	2,20	2,40	2,50	2,80	2,40	2,75	3,05	3,25	2,60	3,10	3,60	3,70	
5,2	26	2,30	2,50	2,70	3,20	2,65	3,05	3,25	3,55	3,00	3,60	3,80	3,90	
6,0	30	2,50	2,70	3,00	3,40	2,85	3,25	3,50	3,75	3,20	3,80	4,00	4,10	





Performance data / Datos de rendimiento



**BLUE DEFLECTOR CC33**  
DEFLECTOR AZUL CC33

**komet | Precision Spray (KPS) 360**

Deflector Specifications / Especificaciones del deflector				Operating Parameters / Parámetros operativos				Installation / Instalación
Trajectory / Trayectoria	Grooves / Ranuras	Type / Tipo	Coverage / Cobertura	Nozzle range / Gama boquillas (1/128")	Pressure range / Gama presiones (psi)	Flow range / Gama caudales (gpm)	Spacing max. / Distancia máx. (ft)	Drop Type / Tipo bajante
Concave / Cóncava	33	Medium / Mediano	360°	8 - 52	6 - 30	0.28 - 26.30	11	All Types / Todos los tipos

Nozzle Size / Tamaño boquilla (1/128")	Throw Diameter / Diámetro alcance D (ft)												Stream Height / Altura chorro S (in)							
	Installation Height / Altura instalación H=3ft				Installation Height / Altura instalación H=6ft				Installation Height / Altura instalación H=9ft											
	Pressure / Presión (psi)				Pressure / Presión (psi)				Pressure / Presión (psi)				Pressure / Presión (psi)							
	6	10	15	20	6	10	15	20	6	10	15	20	6	10	15	20	6	10	15	20
8	15.8	19.5	23.1	26.0	19.3	23.9	28.2	31.9	21.7	26.9	31.8	35.9	1	2	2	2				
16	19.9	24.7	29.1	32.9	24.3	30.2	35.6	40.2	27.4	34.0	40.1	45.3	1	3	4	4				
23	22.4	27.8	32.9	37.1	27.5	34.1	40.3	45.4	30.9	38.4	45.3	51.1	2	4	5	6				
29	24.3	30.1	35.5	40.1	29.7	36.9	43.5	49.1	33.4	41.5	49.0	55.3	2	5	5	6				
34	25.6	31.7	37.5	42.3	31.3	38.9	45.9	51.8	35.3	43.8	51.7	58.3	3	5	6	7				
40	27.0	33.5	39.6	44.7	33.1	41.1	48.5	54.7	37.3	46.2	54.6	61.6	3	6	7	8				
45	28.1	34.9	41.2	46.5	34.4	42.7	50.4	56.9	38.8	48.1	56.7	64.1	3	6	7	9				
52	29.5	36.6	43.2	48.8	36.1	44.8	52.9	59.7	40.7	50.5	59.6	67.2	4	7	8	10				



**BLACK DEFLECTOR FL33**  
DEFLECTOR NEGRO FL33

**komet | Precision Spray (KPS) 360**

Deflector Specifications / Especificaciones del deflector				Operating Parameters / Parámetros operativos				Installation / Instalación
Trajectory / Trayectoria	Grooves / Ranuras	Type / Tipo	Coverage / Cobertura	Nozzle range / Gama boquillas (1/128")	Pressure range / Gama presiones (psi)	Flow range / Gama caudales (gpm)	Spacing max. / Distancia máx. (ft)	Drop Type / Tipo bajante
Flat / Plana	33	Medium / Mediano	360°	8 - 52	6 - 30	0.28 - 26.30	11	All Types / Todos los tipos

Nozzle Size / Tamaño boquilla (1/128")	Throw Diameter / Diámetro alcance D (ft)												Stream Height / Altura chorro S (in)							
	Installation Height / Altura instalación H=3ft				Installation Height / Altura instalación H=6ft				Installation Height / Altura instalación H=9ft											
	Pressure / Presión (psi)				Pressure / Presión (psi)				Pressure / Presión (psi)				Pressure / Presión (psi)							
	6	10	15	20	6	10	15	20	6	10	15	20	6	10	15	20	6	10	15	20
8	15.3	18.8	22.1	24.8	19.1	23.5	27.6	31.0	21.8	26.9	31.5	35.4								
16	19.1	23.5	27.6	31.0	23.9	29.4	34.5	38.8	27.3	33.6	39.4	44.3								
23	21.5	26.4	31.0	34.9	26.9	33.1	38.8	43.6	30.7	37.8	44.3	49.8								
29	23.1	28.5	33.4	37.6	29.0	35.7	41.9	47.0	33.0	40.7	47.7	53.7								
34	24.4	30.0	35.2	39.5	30.5	37.5	44.1	49.5	34.8	42.8	50.3	56.5								
40	25.7	31.6	37.1	41.7	32.1	39.6	46.4	52.2	36.7	45.1	53.0	59.5								
45	26.7	32.8	38.5	43.3	33.4	41.1	48.2	54.2	38.1	46.9	55.0	61.8								
52	27.9	34.4	40.4	45.4	35.0	43.1	50.5	56.8	39.9	49.1	57.6	64.8								



Performance data / Datos de rendimiento



**GREY DEFLECTOR FL24**  
DEFLECTOR GRIS FL24

**komet | Precision Spray (KPS) 360**

Deflector Specifications / Especificaciones del deflector				Operating Parameters / Parámetros operativos				Installation / Instalación
Trajectory / Trayectoria	Grooves / Ranuras	Type / Tipo	Coverage / Cobertura	Nozzle range / Gama boquillas (1/128")	Pressure range / Gama presiones (psi)	Flow range / Gama caudales (gpm)	Spacing max. / Distancia máx. (ft)	Drop Type / Tipo bajante
Flat / Plana	24	Deep / Profundo	360°	8 - 52	6 - 30	0.28 - 26.30	11	All Types / Todos los tipos

Nozzle Size / Tamaño boquilla (1/128")	Throw Diameter / Diámetro alcance D (ft)												Stream Height / Altura chorro S (in)							
	Installation Height / Altura instalación H=3ft				Installation Height / Altura instalación H=6ft				Installation Height / Altura instalación H=9ft											
	Pressure / Presión (psi)				Pressure / Presión (psi)				Pressure / Presión (psi)				Pressure / Presión (psi)							
	6	10	15	20	6	10	15	20	6	10	15	20	6	10	15	20	6	10	15	20
8	17.1	21.4	25.4	28.8	21.9	27.4	32.5	36.8	25.4	31.7	37.6	42.6								
16	19.9	24.8	29.5	33.4	25.5	31.8	37.7	42.7	29.4	36.8	43.6	49.4								
23	21.5	26.8	31.8	36.1	27.5	34.4	40.8	46.2	31.8	39.7	47.2	53.4								
29	22.6	28.2	33.5	37.9	28.9	36.1	42.9	48.6	33.5	41.8	49.6	56.2								
34	23.4	29.2	34.6	39.2	30.0	37.4	44.4	50.3	34.6	43.2	51.3	58.1								
40	24.2	30.2	35.9	40.6	31.0	38.7	46.0	52.1	35.9	44.8	53.1	60.2								
45	24.8	31.0	36.8	41.7	31.8	39.7	47.1	53.4	36.8	45.9	54.5	61.7								
52	25.6	32.0	38.0	43.0	32.8	41.0	48.6	55.1	37.9	47.4	56.2	63.7								



**YELLOW DEFLECTOR FL30**  
DEFLECTOR AMARILLO FL30

**komet | Precision Spray (KPS) 360**

Deflector Specifications / Especificaciones del deflector				Operating Parameters / Parámetros operativos				Installation / Instalación
Trajectory / Trayectoria	Grooves / Ranuras	Type / Tipo	Coverage / Cobertura	Nozzle range / Gama boquillas (1/128")	Pressure range / Gama presiones (psi)	Flow range / Gama caudales (gpm)	Spacing max. / Distancia máx. (ft)	Drop Type / Tipo bajante
Flat / Plana	30	Fine / Fino	360°	8 - 52	6 - 30	0.28 - 26.30	11	All Types / Todos los tipos

Nozzle Size / Tamaño boquilla (1/128")	Throw Diameter / Diámetro alcance D (ft)												Stream Height / Altura chorro S (in)							
	Installation Height / Altura instalación H=3ft				Installation Height / Altura instalación H=6ft				Installation Height / Altura instalación H=9ft											
	Pressure / Presión (psi)				Pressure / Presión (psi)				Pressure / Presión (psi)				Pressure / Presión (psi)							
	6	10	15	20	6	10	15	20	6	10	15	20	6	10	15	20	6	10	15	20
8	15.3	18.8	22.1	24.8	19.6	24.1	28.2	31.7	22.6	27.8	32.6	36.6								
16	18.4	22.6	26.5	29.7	23.4	28.8	33.8	38.0	27.1	33.3	39.0	43.8								
23	20.2	24.8	29.1	32.7	25.8	31.7	37.2	41.8	29.7	36.6	42.9	48.2								
29	21.4	26.4	30.9	34.8	27.4	33.7	39.5	44.4	31.6	38.9	45.6	51.2								
34	22.4	27.5	32.3	36.2	28.6	35.1	41.2	46.3	32.9	40.5	47.5	53.4								
40	23.3	28.7	33.7	37.8	29.8	36.7	43.0	48.3	34.4	42.3	49.6	55.7								
45	24.1	29.6	34.7	39.0	30.7	37.8	44.3	49.8	35.5	43.6	51.2	57.5								
52	25.0	30.7	36.0	40.5	31.9	39.3	46.0	51.7	36.8	45.3	53.1	59.7								





Performance data / Datos de rendimiento



**MINI BLACK DEFLECTOR FL24**  
MINI DEFLECTOR NEGRO FL24

**komet | Precision Spray (KPS) 360**

Deflector Specifications / Especificaciones del deflector				Operating Parameters / Parámetros operativos				Installation / Instalación
Trajectory / Trayectoria	Grooves / Ranuras	Type / Tipo	Coverage / Cobertura	Nozzle range / Gama boquillas (1/128")	Pressure range / Gama presiones (psi)	Flow range / Gama caudales (gpm)	Spacing max. / Distancia máx. (ft)	Drop Type / Tipo bajante
Flat / Plana	24	Medium / Mediano	360°	8 - 18	6 - 30	0.28 - 3.27	11	All Types / Todos los tipos

Nozzle Size / Tamaño boquilla (1/128")	Throw Diameter / Diámetro alcance D (ft)												Stream Height / Altura chorro S (in)							
	Installation Height / Altura instalación H=3ft				Installation Height / Altura instalación H=6ft				Installation Height / Altura instalación H=9ft											
	Pressure / Presión (psi)				Pressure / Presión (psi)				Pressure / Presión (psi)				Pressure / Presión (psi)							
	6	10	15	20	6	10	15	20	6	10	15	20	6	10	15	20	FLAT PLANA			
8	18.3	22.4	26.3	29.5	23.0	28.2	33.0	37.1	26.3	32.3	37.8	42.4								
18	22.2	27.3	31.9	35.8	28.0	34.3	40.2	45.1	32.0	39.3	46.0	51.6								

**komet | Precision Spray (KPS) 360**



**MINI TURQUOISE DEFLECTOR FL**  
MINI DEFLECTOR TURQUESA FL

Deflector Specifications / Especificaciones del deflector				Operating Parameters / Parámetros operativos				Installation / Instalación
Trajectory / Trayectoria	Grooves / Ranuras	Type / Tipo	Coverage / Cobertura	Nozzle range / Gama boquillas (1/128")	Pressure range / Gama presiones (psi)	Flow range / Gama caudales (gpm)	Spacing max. / Distancia máx. (ft)	Drop Type / Tipo bajante
Flat / Plana	0	Smooth / Liso	360°	8 - 52	6 - 30	0.28 - 26.30	11	All Types / Todos los tipos

Nozzle Size / Tamaño boquilla (1/128")	Throw Diameter / Diámetro alcance D (ft)												Stream Height / Altura chorro S (in)							
	Installation Height / Altura instalación H=3ft				Installation Height / Altura instalación H=6ft				Installation Height / Altura instalación H=9ft											
	Pressure / Presión (psi)				Pressure / Presión (psi)				Pressure / Presión (psi)				Pressure / Presión (psi)							
	6	10	15	20	6	10	15	20	6	10	15	20	6	10	15	20	FLAT PLANA			
8	14.3	15.5	16.4	17.1	17.5	18.9	20.0	20.9	19.7	21.3	22.5	23.5								
16	17.4	18.8	19.9	20.7	21.3	23.0	24.3	25.4	24.0	25.8	27.4	28.5								
23	19.3	20.8	22.0	23.0	23.6	25.4	26.9	28.1	26.5	28.6	30.3	31.6								
29	20.6	22.2	23.5	24.5	25.2	27.1	28.8	30.0	28.3	30.5	32.4	33.7								
34	21.5	23.2	24.6	25.7	26.3	28.4	30.1	31.4	29.6	31.9	33.8	35.3								
40	22.5	24.3	25.7	26.9	27.6	29.7	31.5	32.8	31.0	33.4	35.4	37.0								
45	23.3	25.1	26.6	27.8	28.5	30.7	32.6	34.0	32.1	34.6	36.6	38.2								
52	24.3	26.2	27.7	28.9	29.7	32.0	33.9	35.4	33.4	36.0	38.1	39.8								

For optimal performance of the Komet Precision Spray (KPS) when installed on drop pipes, it is recommended to use the maximum spacing up to the 2nd span only. Keep the Komet Precision Spray (KPS) out of the crop canopy when spacing exceeds 10 ft. Install the Komet Precision Spray (KPS) with a ground clearance of at least 3 ft. Performance data regarding flow and throw in relation to installation height and deflector type shown in the tables, originate from the mathematical model used in the Komet Pivot Calculator software. Performance data was obtained under ideal testing conditions and is the base for the mathematical model. Pressure refers to pressure at nozzle. Stream height is the height from the deflector to the highest droplets in the trajectory profile. Performance may be adversely affected by wind and other factors.

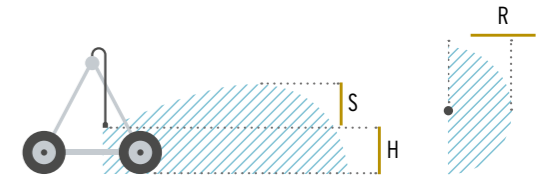

Performance data / Datos de rendimiento



**BLUE DEFLECTOR CC15 - PC180**  
DEFLECTOR AZUL CC15 - PC180

**komet | Precision Spray (KPS) 180 Part Circle**

Deflector Specifications / Especificaciones del deflector				Operating Parameters / Parámetros operativos				Installation / Instalación
Trajectory / Trayectoria	Grooves / Ranuras	Type / Tipo	Coverage / Cobertura	Nozzle range / Gama boquillas (1/128")	Pressure range / Gama presiones (psi)	Flow range / Gama caudales (gpm)	Spacing max. / Distancia máx. (ft)	Drop Type / Tipo bajante
Concave / Cóncava	15	Medium / Mediano	180°	8 - 40	6 - 30	0.28 - 15.54	11	Rigid drops only / Bajantes rígidos

Nozzle Size / Tamaño boquilla (1/128")	Throw Radius / Radio alcance R (ft)												Stream Height / Altura chorro S (in)							
	Installation Height / Altura instalación H=3ft				Installation Height / Altura instalación H=6ft				Installation Height / Altura instalación H=9ft											
	Pressure / Presión (psi)				Pressure / Presión (psi)				Pressure / Presión (psi)				Pressure / Presión (psi)							
	6	10	15	20	6	10	15	20	6	10	15	20	6	10	15	20	6	10	15	20
8	7.9	9.8	11.5	13.0	9.6	12.0	14.1	15.9	10.9	13.5	15.9	17.9	1	2	2	2				
16	9.9	12.3	14.6	16.4	12.2	15.1	17.8	20.1	13.7	17.0	20.1	22.6	1	3	4	4				
23	11.2	13.9	16.4	18.6	13.7	17.0	20.1	22.7	15.5	19.2	22.7	25.6	2	4	5	6				
29	12.1	15.1	17.8	20.1	14.9	18.4	21.8	24.6	16.7	20.7	24.5	27.6	2	5	5	6				
34	12.8	15.9	18.7	21.2	15.7	19.4	22.9	25.9	17.6	21.9	25.8	29.2	3	5	6	7				
40	13.5	16.8	19.8	22.3	16.5	20.5	24.2	27.3	18.6	23.1	27.3	30.8	3	5	6	7				

Para un óptimo rendimiento del Komet Precision Spray (KPS) es recomendable que, al instalar las tuberías de los bajantes, se use la máxima distancia sólo hasta el segundo tramo. Mantenga el Komet Precision Spray (KPS) fuera del dosel del cultivo, si la distancia sobrepasa 10 ft. Instale el Komet Precision Spray (KPS) con una distancia del suelo al aspersor de por lo menos 3 ft. Los datos de rendimiento, referentes a caudal y alcance en relación a la altura de instalación y tipo de deflector, que figuran en la tabla, tienen su origen en el modelo matemático, usado en el software del Komet Pivot Calculator. Los datos de rendimiento fueron obtenidos bajo condiciones de ensayo ideales y son base del modelo matemático. La presión se refiere a la presión a la boquilla. La altura del chorro se refiere a la altura a partir del deflector, hasta el punto más alto del perfil del chorro. Los datos referentes al caudal fueron obtenidos bajo condiciones de ensayo ideales y pueden ser afectados por un deficiente flujo hidráulico, turbulencias y otras condiciones.





Performance data / Datos de rendimiento



**BLUE DEFLECTOR CC33**  
DEFLECTOR AZUL CC33

**komet | Precision Spray (KPS) Dual**

Deflector Specifications / Especificaciones del deflector				Operating Parameters / Parámetros operativos				Installation / Instalación
Trajectory / Trayectoria	Grooves / Ranuras	Type / Tipo	Coverage / Cobertura	Nozzle range / Gama boquillas (1/128")	Pressure range / Gama presiones (psi)	Flow range / Gama caudales (gpm)	Spacing max. / Distancia máx. (ft)	Drop Type / Tipo bajante
Concave / Cóncava	33	Medium / Mediano	360°	8 - 29	6 - 30	0.28 - 8.26	11	All Types / Todos los tipos

Nozzle Size / Tamaño boquilla (1/128")	Throw Diameter / Diámetro alcance D (ft)								Stream Height / Altura chorro S (in)			
	Installation Height / Altura instalación H=3ft				Installation Height / Altura instalación H=6ft							
	Pressure / Presión (psi)				Pressure / Presión (psi)				Pressure / Presión (psi)			
	6	10	15	20	6	10	15	20	6	10	15	20
8	15.8	19.5	23.1	26.0	19.3	23.9	28.2	31.9	1	2	2	2
16	19.9	24.7	29.1	32.9	24.3	30.2	35.6	40.2	1	3	4	4
23	22.4	27.8	32.9	37.1	27.5	34.1	40.3	45.4	2	4	5	6
29	24.3	30.1	35.5	40.1	29.7	36.9	43.5	49.1	2	5	5	6



**BLUE DEFLECTOR W/HOLE CC33**  
DEFLECTOR AZUL CON AGUJERO CC33

**BLACK DEFLECTOR FL33**  
DEFLECTOR NEGRO FL33

**komet | Precision Spray (KPS) Dual**

Deflector Specifications / Especificaciones del deflector				Operating Parameters / Parámetros operativos				Installation / Instalación
Trajectory / Trayectoria	Grooves / Ranuras	Type / Tipo	Coverage / Cobertura	Nozzle range / Gama boquillas (1/128")	Pressure range / Gama presiones (psi)	Flow range / Gama caudales (gpm)	Spacing max. / Distancia máx. (ft)	Drop Type / Tipo bajante
Flat / Plana	33	Medium / Mediano	360°	30 - 52	6 - 30	3.92 - 26.30	11	All Types / Todos los tipos

Nozzle Size / Tamaño boquilla (1/128")	Throw Diameter / Diámetro alcance D (ft)								Stream Height / Altura chorro S (in)			
	Installation Height / Altura instalación H=3ft				Installation Height / Altura instalación H=6ft							
	Pressure / Presión (psi)				Pressure / Presión (psi)				Pressure / Presión (psi)			
	6	10	15	20	6	10	15	20	6	10	15	20
30	23.0	29.2	32.8	37.1	26.9	33.5	40.7	43.3	2	5	5	6
34	23.6	30.2	33.5	38.1	28.9	34.8	42.0	44.6	3	5	6	7
40	25.6	32.5	37.4	40.0	30.8	38.7	44.0	45.9	3	6	7	8
45	27.6	35.1	39.7	44.3	32.8	40.0	45.9	49.9	3	6	7	9
52	29.2	38.7	41.0	45.9	36.1	42.0	46.6	51.2	4	7	8	10

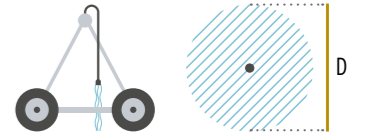

Performance data / Datos de rendimiento



**BROWN DEFLECTOR WB60**  
DEFLECTOR MARRÓN WB60

**komet | Precision Spray (KPS) Vertical Bubbler**

Deflector Specifications / Especificaciones deflector			Operating Parameters / Parámetros operativos				Installation / Instalación	
Trajectory / Trayectoria	Coverage / Cobertura	Nozzle range / Gama boquillas (1/128")	Pressure range / Gama presiones (psi)	Flow range / Gama caudales (gpm)	Spacing max. / Distancia máx. (in)	Installation height / Altura de instalación (in)	Drop Type / Tipo bajante	
Vertical / Vertical	Localized / Localizado	8 - 45	6 - 30	0.28 - 19.46	30" - 60" Furrow Dependent / Surco Dependiente	8" - 18"	All Types / Todos los tipos	

The reverse side of the Vertical Bubbler deflector corresponds with the Komet Precision Spray (KPS) deflector 360 in the respective colour. For the performance data please refer to the tables for Komet Precision Spray (KPS) deflectors 360.  
El reverso del deflector Vertical Bubbler se corresponde con el deflector 360 de Komet Precision Spray (KPS) en el color respectivo. Los datos técnicos se encuentran en las tablas de deflectores Komet Precision Spray (KPS) 360.

**komet | Precision Spray (KPS) Wide Bubbler 60"**

Deflector Specifications / Especificaciones deflector			Operating Parameters / Parámetros operativos				Installation / Instalación	
Trajectory / Trayectoria	Coverage / Cobertura	Nozzle range / Gama boquillas (1/128")	Pressure range / Gama presiones (psi)	Flow range / Gama caudales (gpm)	Spacing max. / Distancia máx. (ft)	Installation height / Altura de instalación (ft)	Drop Type / Tipo bajante	
Dome / Dome	360°	9 - 30	6 - 30	0.36 - 8.84	5	1.5 - 2.5	All Types / Todos los tipos	

Nozzle Size / Tamaño boquilla (1/128")	Throw Diameter / Diámetro alcance D (ft)											
	Installation Height / Altura instalación H=1.5ft				Installation Height / Altura instalación H=2ft				Installation Height / Altura instalación H=2.5ft			
	Pressure / Presión (psi)				Pressure / Presión (psi)				Pressure / Presión (psi)			
	6	10	15	20	6	10	15	20	6	10	15	20
9	3.3	4.3	5.9	6.2	3.6	4.8	6.6	7.1	3.9	5.2	7.2	7.9
10	4.6	4.9	6.2	6.6	4.8	5.7	7.1	7.5	4.9	6.6	7.9	8.5
11	4.9	5.2	6.6	7.2	5.2	6.1	7.4	8.0	5.6	6.9	8.2	8.9
12	5.2	5.9	7.2	7.5	5.7	6.6	7.9	8.4	6.2	7.2	8.5	9.2
14	5.9	6.2	7.5	8.2	6.2	7.2	8.5	9.2	6.6	8.2	9.5	10.2
18	6.6	6.9	7.9	8.9	7.2	8.0	9.2	10.2	7.9	9.2	10.5	11.5
22	7.2	7.9	8.2	9.2	7.9	9.0	10.0	10.7	8.5	10.2	11.8	12.1
26	7.5	8.2	8.9	10.5	8.7	10.0	10.7	11.6	9.8	11.8	12.5	12.8
30	8.2	8.9	9.8	11.2	9.4	10.7	11.5	12.3	10.5	12.5	13.1	13.5





**komet** | *Pivot*

Komet Precision Regulator (KPR-X)







komet | *Precision Regulator (KPR-X)*

Komet Precision Regulator 10psi on drops  
Komet Precision Regulator 10psi en bajantes



# komet | Precision Regulator (KPR-X)

## Reliability Over Time and Optimal Plugging Resistance / Fiabilidad a lo Largo del Tiempo y Resistencia a Obstrucción

The new axial design with a concentric arrangement of all components, allows for uniformly applied flow forces around the plunger. This significantly reduces wear of the plunger seal and in turn improves the reliability over time.

The optimized plunger diameter ensures the greatest possible gap between the plunger and the valve seat. Not only does that allow for maximum flows, it significantly helps to reduce plugging in water conditions with sand and debris.

The unique progressive dampening system considerably contributes to the reliable and durable performance of the Komet Precision Regulator (KPR-X), protecting the regulator and downstream installed components effectively against water hammers.

The diaphragm chamber has an innovative self-cleaning mechanism that allows to drain the water with sand and debris at shutdown.

El nuevo diseño axial con una disposición concéntrica de todos los componentes permite una aplicación de la fuerza del flujo uniforme alrededor del émbolo. Esto reduce significativamente el desgaste del sello de émbolo y a la vez mejora la fiabilidad a lo largo del tiempo.

El diámetro optimizado del émbolo garantiza la mayor apertura posible entre el émbolo y el asiento de la válvula. Esto no sólo permite obtener el máximo flujo, como también ayuda considerablemente a reducir obstrucciones en condiciones de agua con arena y escombros.

El singular sistema de amortiguación progresivo contribuye considerablemente a un rendimiento fiable y duradero del Komet Precision Regulator (KPR-X), protegiendo el regulador y todos los componentes instalados descendente de manera eficaz contra golpes de agua.

La cámara del diafragma dispone de un mecanismo innovador de autolimpieza que permite drenar el agua con arena y escombros cuando el sistema está en la parada.

## Enhanced and Durable Performance / Rendimiento Mejorado y Duradero

The large entrance chamber with its radially arranged, unique flow deviation fins, directs the flow in a circular motion towards the plunger. That in combination with the optimized plunger diameter and the resulting flow dependent, maximum gap between plunger and valve seat, contributes to the all-flow capability and the low friction losses of the Komet Precision Regulator (KPR-X).

The very low hysteresis of the Komet Precision Regulator (KPR-X) is the result of the internal configuration, the unique progressive dampening system with no friction between the components, and the tribological properties of the interacting surfaces in relative motion.

La mayor apertura de la cámara de entrada, junto a las aletas de desvío del flujo dispuestas radialmente, dirige el flujo en un movimiento circular en dirección al émbolo. Esto, en combinación con el diámetro optimizado del émbolo, y la apertura máxima entre el émbolo y el asiento de la válvula en relación del flujo, contribuye a una capacidad de flujo mayor y bajas pérdidas por fricción del Komet Precision Regulator (KPR-X).

La muy baja histéresis del Komet Precision Regulator (KPR-X) es el resultado de la configuración interna y el sistema único de amortiguación progresivo sin fricción entre los componentes.

## Precision Manufacturing and High-Quality Materials / Fabricación de Precisión y Materiales de Alta Calidad

All components of the Komet Precision Regulator (KPR-X) are of high-quality materials, precision manufactured and carefully controlled throughout the fully automated assembly process. Each critical component is 100 % individually tested prior to assembly. The very tight manufacturing tolerances allow for an excellent regulating performance.

Todos los componentes del Komet Precision Regulator (KPR-X) son de materiales de alta calidad, fabricados con precisión y controlados cuidadosamente durante todo el proceso de montaje totalmente automatizado. Cada componente crítico es testado al 100 % individualmente antes del montaje. Las muy estrictas tolerancias de fabricación permiten un excelente rendimiento de regulación.

Technical Specifications Komet Precision Regulator (KPR-X) / Especificaciones técnicas Komet Precision Regulator (KPR-X)

Model / Modelo	Flow Range covers complete Nozzle Range / Rango de Caudales cubre toda la Gama de Boquillas		Flow range / Rango de Caudales				Nominal Regulated Outlet Pressure / Presión Regulada de Salida Nominal		Max. Inlet Pressure / Presión Max. de Entrada		Connection Inlet/Outlet / Conexión Entrada/Salida
	in	mm	min		max		psi	bar	psi	bar	
			l/h	gpm	l/h	gpm					
KPR-X 6	8 - 52 / 128"	1.6 - 10.3	63.6	0.28	2726	12.0	6	0.4	120	8.3	3/4" x 3/4" FNPT
KPR-X 10	8 - 52 / 128"	1.6 - 10.3	84.0	0.37	3407	15.0	10	0.7	120	8.3	3/4" x 3/4" FNPT
KPR-X 15	8 - 52 / 128"	1.6 - 10.3	90.8	0.45	4088	18.0	15	1.0	120	8.3	3/4" x 3/4" FNPT
KPR-X 20	8 - 52 / 128"	1.6 - 10.3	118.1	0.52	4543	20.0	20	1.4	120	8.3	3/4" x 3/4" FNPT

The pressure regulators will operate at the preset operating pressure over the whole nozzle range provided that the inlet pressure is at least 5 psi | 0.35 bar higher than the nominal rated pressure. Los reguladores de presión funcionan a la presión operativa predefinida sobre la entera gama de boquillas, a condición de que la presión de entrada sea por lo menos 5 psi | 0.35 bar más alta que la presión nominal.

## Key features Características clave

Large entrance chamber with unique flow deviation fins  
Gran cámara de entrada con aletas exclusivas de desvío de flujo

Optimal plunger diameter  
Diámetro ideal del émbolo

Precision manufacturing  
Fabricación de precisión

Diaphragm chamber with innovative progressive dampening system and self-flushing capability at shutdown  
Cámara de diafragma con sistema innovador de amortiguación progresivo y capacidad de autolimpieza en la parada

All Flow Pivot Regulator  
Suitable for flow of nozzle sizes 8 - 52/128"  
All-Flow Regulador Pivot  
Adecuado para caudal de los tamaños de boquilla 8 - 52/128"

Technical polymers shock absorbing, UV protected, hard wearing  
Polímeros técnicos resistencia a choques, protección UV, gran durabilidad

Laser markings for long lasting identification  
Marcado láser para una identificación duradera

Very low hysteresis  
Muy baja histéresis

Very low friction loss  
Muy baja pérdida por fricción



Dimensions / Medidas

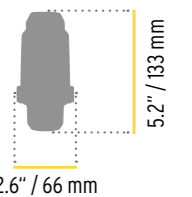

Pat. Pending









komet | *Precision Wave (KPW)*  
Head-down Installation | Yellow Deflector  
Instalación cabeza abajo | Deflector Amarillo



# komet | Precision Wave (KPW)

Appropriate water distribution at the end of a mechanized irrigation system can ensure a significantly increased yield, as well as improve overall crop health. The more uniform the water application beyond the end of the system, the greater the achievable yield.

The Komet Precision Wave (KPW), is a highly innovative End of System distribution device. Its unique design - distinguished by an oscillating deflector - delivers an exceptionally uniform droplet distribution pattern within an optimal throw radius.

Una distribución adecuada de agua al final del sistema de irrigación mecanizado puede asegurar un significativo aumento del rendimiento, así como mejorar en general la salud del cultivo. Cuanto más uniforme es la aplicación de agua más allá del final del sistema, mayor es el rendimiento alcanzable.

El Komet Precision Wave (KPW) es un dispositivo de distribución al final del sistema altamente innovador. Su diseño único - distinguido por un deflector oscilante - proporciona un patrón de distribución de gotas excepcionalmente uniforme, dentro de un óptimo radio de alcance.

## Komet Precision Wave (KPW) Head-up Installation | White Deflector Instalación cabeza arriba | Deflector blanco



Pat. Pending

### Available Models Modelos disponibles

**Komet Precision Wave (KPW)**  
Head-up Installation  
White deflector  
Connection 2" BSP/NPT  
includes 15 cm / 6" Adapter  
Instalación cabeza arriba  
Deflector blanco  
Conexión 2" BSP/NPT  
incl. 15 cm / 6" Adaptador

**Komet Precision Wave (KPW)**  
Head-up Installation  
White deflector  
Connection 1 1/4" BSP/NPT  
includes 15 cm / 6" Adapter  
Instalación cabeza arriba  
Deflector blanco  
Conexión 1 1/4" BSP/NPT  
incl. 15 cm / 6" Adaptador

### Dimensions / Medidas

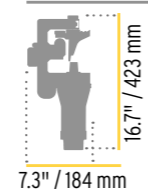

The Komet Precision Wave (KPW) operates in an extended pressure range of 1-4 bar, and includes an assortment of nozzles that have been meticulously calibrated to deliver the precise amount of water required by the sprinkler package design of the irrigation system.

The Komet Precision Wave (KPW) with its available models Head-up White Deflector and Head-down Yellow Deflector, is adaptable to every need - whether the focus is more on throw and gaining acres, or on flushing the system in difficult water situations. For optimal flushing action, which can prevent accumulations of debris at the end of system, bigger nozzle sizes should be used. The available connections, 1 1/4" or 2" with a 6" Adapter for optimal performance, fit every installation set-up.

El Komet Precision Wave (KPW) opera en un rango de presión ampliado de 1-4 bar e incluye un surtido de boquillas, calibradas meticulosamente para proporcionar la precisa cantidad de agua requerida por el diseño de la carta de aspersores del sistema de irrigación.

El Komet Precision Wave (KPW) con sus modelos disponibles, Head-up deflector blanco y Head-down deflector amarillo, es adaptable a todas necesidades - si bien se enfoca más el alcance y la ganancia de área, o la limpieza del sistema en situaciones difíciles del agua. Para una óptima acción de limpieza, que puede prevenir a acumulaciones de escombros al final del sistema, debe utilizarse mayores tamaños de boquillas. Las conexiones disponibles, 1 1/4" o 2" con un adaptador de 6" para un rendimiento óptimo, se adaptan a cualquier configuración de instalación.

## Komet Precision Wave (KPW) Head-down Installation | Yellow Deflector Instalación cabeza abajo | Deflector amarillo



Pat. Pending

### Available Models Modelos disponibles

**Komet Precision Wave (KPW)**  
Head-down Installation  
Yellow deflector  
Connection 2" BSP/NPT  
includes 15 cm / 6" Adapter  
Instalación cabeza abajo  
Deflector amarillo  
Conexión 2" BSP/NPT  
incl. 15 cm / 6" Adaptador

**Komet Precision Wave (KPW)**  
Head-down Installation  
Yellow deflector  
Connection 1 1/4" BSP/NPT  
includes 15 cm / 6" Adapter  
Instalación cabeza abajo  
Deflector amarillo  
Conexión 1 1/4" BSP/NPT  
incl. 15 cm / 6" Adaptador

### Dimensions / Medidas

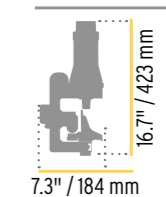





Performance data / Datos de rendimiento



**komet | Precision Wave (KPW) HEAD-UP WHITE DEFLECTOR**  
**CABEZA ARRIBA DEFLECTOR BLANCO**

Operating Parameters / Parámetros operativos			Installation / Instalación
Nozzle range / Gama boquillas (mm)	Pressure range / Gama presiones (bar)	Flow range / Gama caudales (m³/hr)	Head-Up / Cabeza arriba
10 - 18	1 - 4	4,0 - 25,7	

Pressure / Presión	Throw Radius / Radio alcance R (m)																	
	Installation Height / Altura instalación <b>H=4m</b>																	
	Nozzle / Boquilla 10 mm		Nozzle / Boquilla 11 mm		Nozzle / Boquilla 12 mm		Nozzle / Boquilla 13 mm		Nozzle / Boquilla 14 mm		Nozzle / Boquilla 15 mm		Nozzle / Boquilla 16 mm		Nozzle / Boquilla 17 mm		Nozzle / Boquilla 18 mm	
bar	Flow Caudal (m³/h)	Radius Radio (m)	Flow Caudal (m³/h)	Radius Radio (m)	Flow Caudal (m³/h)	Radius Radio (m)	Flow Caudal (m³/h)	Radius Radio (m)	Flow Caudal (m³/h)	Radius Radio (m)	Flow Caudal (m³/h)	Radius Radio (m)	Flow Caudal (m³/h)	Radius Radio (m)	Flow Caudal (m³/h)	Radius Radio (m)	Flow Caudal (m³/h)	Radius Radio (m)
1,0	4,0	9,6	4,8	9,8	5,7	10,0	6,7	10,2	7,8	10,4	8,9	10,5	10,1	10,6	11,4	10,8	12,8	10,8
1,5	4,9	10,7	5,9	10,9	7,0	11,2	8,2	11,4	9,5	11,5	10,9	11,6	12,4	11,8	14,0	12,0	15,7	11,9
2,0	5,6	11,5	6,8	11,8	8,1	12,1	9,5	12,3	11,0	12,5	12,6	12,6	14,3	12,8	16,2	13,0	18,1	13,0
2,5	6,3	12,2	7,6	12,5	9,0	12,8	10,6	13,0	12,3	13,2	14,1	13,4	16,0	13,5	18,1	13,8	20,3	13,8
3,0	6,9	12,7	8,3	13,0	9,9	13,3	11,6	13,5	13,4	13,7	15,4	13,9	17,6	14,1	19,8	14,3	22,2	14,3
3,5	7,4	13,1	9,0	13,4	10,7	13,7	12,5	13,9	14,5	14,1	16,7	14,3	19,0	14,5	21,4	14,7	24,0	14,7
4,0	7,9	13,4	9,6	13,7	11,4	14,0	13,4	14,2	15,5	14,5	17,8	14,6	20,3	14,8	22,9	15,1	25,7	15,1

Pressure / Presión	Throw Radius / Radio alcance R (m)																	
	Installation Height / Altura instalación <b>H=1.85m</b>																	
	Nozzle / Boquilla 10 mm		Nozzle / Boquilla 11 mm		Nozzle / Boquilla 12 mm		Nozzle / Boquilla 13 mm		Nozzle / Boquilla 14 mm		Nozzle / Boquilla 15 mm		Nozzle / Boquilla 16 mm		Nozzle / Boquilla 17 mm		Nozzle / Boquilla 18 mm	
bar	Flow Caudal (m³/h)	Radius Radio (m)	Flow Caudal (m³/h)	Radius Radio (m)	Flow Caudal (m³/h)	Radius Radio (m)	Flow Caudal (m³/h)	Radius Radio (m)	Flow Caudal (m³/h)	Radius Radio (m)	Flow Caudal (m³/h)	Radius Radio (m)	Flow Caudal (m³/h)	Radius Radio (m)	Flow Caudal (m³/h)	Radius Radio (m)	Flow Caudal (m³/h)	Radius Radio (m)
1,0	4,0	9,6	4,8	9,8	5,7	9,9	6,7	10,0	7,8	10,0	8,9	10,2	10,1	10,3	11,4	10,3	12,8	10,5
1,5	4,9	10,4	5,9	10,6	7,0	10,7	8,2	10,8	9,5	10,9	10,9	11,0	12,4	11,2	14,0	11,3	15,7	11,4
2,0	5,6	11,1	6,8	11,3	8,1	11,5	9,5	11,6	11,0	11,7	12,6	11,8	14,3	12,0	16,2	12,1	18,1	12,2
2,5	6,3	11,7	7,6	11,9	9,0	12,1	10,6	12,2	12,3	12,4	14,1	12,5	16,0	12,7	18,1	12,8	20,3	12,9
3,0	6,9	12,2	8,3	12,4	9,9	12,6	11,6	12,8	13,4	12,9	15,4	13,1	17,6	13,2	19,8	13,3	22,2	13,4
3,5	7,4	12,7	9,0	12,8	10,7	13,0	12,5	13,2	14,5	13,4	16,7	13,5	19,0	13,6	21,4	13,8	24,0	13,9
4,0	7,9	13,1	9,6	13,2	11,4	13,4	13,4	13,6	15,5	13,7	17,8	13,9	20,3	14,0	22,9	14,1	25,7	14,3

The performance data were obtained under ideal testing conditions and are the base for the mathematical model. Performance may be adversely affected by wind and other factors. Pressure refers to pressure at nozzle. Performance data regarding flow and throw in relation to installation height and deflector type shown in the tables, originate from the mathematical model used in the Komet Pivot Calculator Software.



Performance data / Datos de rendimiento



**komet | Precision Wave (KPW) HEAD-DOWN YELLOW DEFLECTOR**  
**CABEZA ABAJO DEFLECTOR AMARILLO**

Operating Parameters / Parámetros operativos			Installation / Instalación
Nozzle range / Gama boquillas (mm)	Pressure range / Gama presiones (bar)	Flow range / Gama caudales (m³/hr)	Head-Down / Cabeza abajo
10 - 18	1 - 4	4,0 - 25,7	

Pressure / Presión	Throw Radius / Radio alcance R (m)																	
	Installation Height / Altura instalación <b>H=4m</b>																	
	Nozzle / Boquilla 10 mm		Nozzle / Boquilla 11 mm		Nozzle / Boquilla 12 mm		Nozzle / Boquilla 13 mm		Nozzle / Boquilla 14 mm		Nozzle / Boquilla 15 mm		Nozzle / Boquilla 16 mm		Nozzle / Boquilla 17 mm		Nozzle / Boquilla 18 mm	
bar	Flow Caudal (m³/h)	Radius Radio (m)	Flow Caudal (m³/h)	Radius Radio (m)	Flow Caudal (m³/h)	Radius Radio (m)	Flow Caudal (m³/h)	Radius Radio (m)	Flow Caudal (m³/h)	Radius Radio (m)	Flow Caudal (m³/h)	Radius Radio (m)	Flow Caudal (m³/h)	Radius Radio (m)	Flow Caudal (m³/h)	Radius Radio (m)	Flow Caudal (m³/h)	Radius Radio (m)
1,0	4,0	10,2	4,8	10,4	5,7	10,7	6,7	10,9	7,8	11,1	8,9	11,3	10,1	11,5	11,4	11,7	12,8	11,8
1,5	4,9	11,0	5,9	11,4	7,0	11,6	8,2	11,9	9,5	12,1	10,9	12,3	12,4	12,5	14,0	12,7	15,7	12,8
2,0	5,6	11,5	6,8	11,9	8,1	12,2	9,5	12,4	11,0	12,7	12,6	12,8	14,3	13,1	16,2	13,3	18,1	13,5
2,5	6,3	12,0	7,6	12,3	9,0	12,6	10,6	12,9	12,3	13,1	14,1	13,3	16,0	13,5	18,1	13,7	20,3	13,9
3,0	6,9	12,3	8,3	12,7	9,9	13,0	11,6	13,2	13,4	13,4	15,4	13,7	17,6	13,9	19,8	14,1	22,2	14,3
3,5	7,4	12,6	9,0	12,9	10,7	13,3	12,5	13,5	14,5	13,7	16,7	14,0	19,0	14,2	21,4	14,4	24,0	14,6
4,0	7,9	12,9	9,6	13,2	11,4	13,6	13,4	13,8	15,5	14,0	17,8	14,3	20,3	14,5	22,9	14,7	25,7	14,9

Pressure / Presión	Throw Radius / Radio alcance R (m)																	
	Installation Height / Altura instalación <b>H=1.85m</b>																	
	Nozzle / Boquilla 10 mm		Nozzle / Boquilla 11 mm		Nozzle / Boquilla 12 mm		Nozzle / Boquilla 13 mm		Nozzle / Boquilla 14 mm		Nozzle / Boquilla 15 mm		Nozzle / Boquilla 16 mm		Nozzle / Boquilla 17 mm		Nozzle / Boquilla 18 mm	
bar	Flow Caudal (m³/h)	Radius Radio (m)	Flow Caudal (m³/h)	Radius Radio (m)	Flow Caudal (m³/h)	Radius Radio (m)	Flow Caudal (m³/h)	Radius Radio (m)	Flow Caudal (m³/h)	Radius Radio (m)	Flow Caudal (m³/h)	Radius Radio (m)	Flow Caudal (m³/h)	Radius Radio (m)	Flow Caudal (m³/h)	Radius Radio (m)	Flow Caudal (m³/h)	Radius Radio (m)
1,0	4,0	9,0	4,8	9,3	5,7	9,5	6,7	9,7	7,8	9,9	8,9	10,1	10,1	10,1	11,4	10,2	12,8	10,3
1,5	4,9	9,9	5,9	10,3	7,0	10,5	8,2	10,7	9,5	10,8	10,9	11,0	12,4	11,1	14,0	11,3	15,7	11,4
2,0	5,6	10,6	6,8	11,0	8,1	11,2	9,5	11,4	11,0	11,6	12,6	11,7	14,3	11,9	16,2	12,1	18,1	12,2
2,5	6,3	11,2	7,6	11,5	9,0	11,8	10,6	12,0	12,3	12,2	14,1	12,3	16,0	12,5	18,1	12,7	20,3	12,8
3,0	6,9	11,6	8,3	12,0	9,9	12,2	11,6	12,5	13,4	12,7	15,4	12,9	17,6	13,0	19,8	13,2	22,2	13,3
3,5	7,4	12,0	9,0	12,4	10,7	12,6	12,5	12,9	14,5	13,1	16,7	13,3	19,0	13,4	21,4	13,6	24,0	13,8
4,0	7,9	12,3	9,6	12,7	11,4	13,0	13,4	13,3	15,5	13,5	17,8	13,7	20,3	13,8	22,9	14,0	25,7	14,1

Los datos de rendimiento fueron obtenidos bajo condiciones de ensayo ideales y son base del modelo matemático. El rendimiento puede ser afectado negativamente por el viento y otros factores. La presión se refiere a la presión a la boquilla. Los datos de rendimiento, referentes a caudal y alcance en relación a la altura de instalación y tipo de deflector, que figuran en la tabla, tienen su origen en el modelo matemático, usado en el software del Komet Pivot Calculator.





Performance data / Datos de rendimiento



**komet | Precision Wave (KPW) HEAD-UP WHITE DEFLECTOR**  
**CABEZA ARRIBA DEFLECTOR BLANCO**

Operating Parameters / Parámetros operativos			Installation / Instalación
Nozzle range / Gama boquillas (1/128")	Pressure range / Gama presiones (psi)	Flow range / Gama caudales (gpm)	Head-Up / Cabeza arriba
52 - 90	15 - 60	17.7 - 114.9	

Pressure / Presión	Throw Radius / Radio alcance R (ft)																	
	Installation Height / Altura instalación <b>H=13ft</b>																	
	Nozzle / Boquilla 52 1/128"		Nozzle / Boquilla 56 1/128"		Nozzle / Boquilla 60 1/128"		Nozzle / Boquilla 65 1/128"		Nozzle / Boquilla 70 1/128"		Nozzle / Boquilla 75 1/128"		Nozzle / Boquilla 80 1/128"		Nozzle / Boquilla 85 1/128"		Nozzle / Boquilla 90 1/128"	
psi	Flow Caudal (gpm)	Radius Radio (ft)	Flow Caudal (gpm)	Radius Radio (ft)	Flow Caudal (gpm)	Radius Radio (ft)	Flow Caudal (gpm)	Radius Radio (ft)	Flow Caudal (gpm)	Radius Radio (ft)	Flow Caudal (gpm)	Radius Radio (ft)	Flow Caudal (gpm)	Radius Radio (ft)	Flow Caudal (gpm)	Radius Radio (ft)	Flow Caudal (gpm)	Radius Radio (ft)
15	17,7	31,8	21,5	32,4	25,5	33,1	30,0	33,7	34,8	34,4	39,9	34,8	45,4	35,0	51,2	35,4	57,5	35,7
20	20,5	34,3	24,8	34,9	29,5	35,7	34,6	36,5	40,1	36,8	46,1	37,3	52,4	37,7	59,2	38,1	66,3	38,6
25	22,9	36,4	27,7	37,2	33,0	38,0	38,7	38,8	44,9	39,2	51,5	39,7	58,6	40,1	66,2	40,6	74,2	41,0
30	25,1	38,2	30,3	39,1	36,1	40,0	42,4	40,7	49,2	41,2	56,4	41,8	64,2	42,2	72,5	42,7	81,3	43,1
35	27,1	39,7	32,8	40,6	39,0	41,6	45,8	42,2	53,1	42,9	60,9	43,5	69,3	44,0	78,3	44,5	87,8	44,8
40	29,0	40,9	35,0	42,0	41,7	42,9	48,9	43,5	56,8	44,3	65,2	44,8	74,1	45,4	83,7	45,8	93,8	46,2
45	30,7	42,0	37,2	43,0	44,2	43,9	51,9	44,6	60,2	45,3	69,1	45,9	78,6	46,5	88,8	46,9	99,5	47,2
50	32,4	42,9	39,2	43,8	46,6	44,8	54,7	45,5	63,5	46,2	72,8	46,7	82,9	47,4	93,6	47,8	104,9	48,1
55	34,0	43,6	41,1	44,6	48,9	45,6	57,4	46,2	66,6	47,0	76,4	47,5	86,9	48,1	98,1	48,6	110,0	48,9
60	35,5	44,3	42,9	45,2	51,1	46,2	59,9	46,8	69,5	47,7	79,8	48,2	90,8	48,8	102,5	49,2	114,9	49,6

Pressure / Presión	Throw Radius / Radio alcance R (ft)																	
	Installation Height / Altura instalación <b>H=6ft</b>																	
	Nozzle / Boquilla 52 1/128"		Nozzle / Boquilla 56 1/128"		Nozzle / Boquilla 60 1/128"		Nozzle / Boquilla 65 1/128"		Nozzle / Boquilla 70 1/128"		Nozzle / Boquilla 75 1/128"		Nozzle / Boquilla 80 1/128"		Nozzle / Boquilla 85 1/128"		Nozzle / Boquilla 90 1/128"	
psi	Flow Caudal (gpm)	Radius Radio (ft)	Flow Caudal (gpm)	Radius Radio (ft)	Flow Caudal (gpm)	Radius Radio (ft)	Flow Caudal (gpm)	Radius Radio (ft)	Flow Caudal (gpm)	Radius Radio (ft)	Flow Caudal (gpm)	Radius Radio (ft)	Flow Caudal (gpm)	Radius Radio (ft)	Flow Caudal (gpm)	Radius Radio (ft)	Flow Caudal (gpm)	Radius Radio (ft)
15	17,7	31,7	21,5	32,2	25,5	32,5	30,0	32,9	34,8	33,1	39,9	33,6	45,4	33,9	51,2	34,1	57,5	34,6
20	20,5	33,5	24,8	34,0	29,5	34,5	34,6	34,8	40,1	35,2	46,1	35,6	52,4	35,9	59,2	36,2	66,3	36,6
25	22,9	35,2	27,7	35,7	33,0	36,3	38,7	36,7	44,9	37,1	51,5	37,4	58,6	37,8	66,2	38,2	74,2	38,5
30	25,1	36,7	30,3	37,2	36,1	37,9	42,4	38,3	49,2	38,8	56,4	39,2	64,2	39,6	72,5	40,0	81,3	40,3
35	27,1	38,1	32,8	38,6	39,0	39,2	45,8	39,8	53,1	40,3	60,9	40,8	69,3	41,2	78,3	41,5	87,8	41,9
40	29,0	39,4	35,0	39,8	41,7	40,5	48,9	41,1	56,8	41,6	65,2	42,1	74,1	42,5	83,7	42,9	93,8	43,2
45	30,7	40,5	37,2	40,9	44,2	41,5	51,9	42,2	60,2	42,7	69,1	43,2	78,6	43,5	88,8	44,0	99,5	44,4
50	32,4	41,5	39,2	41,9	46,6	42,5	54,7	43,2	63,5	43,7	72,8	44,2	82,9	44,5	93,6	45,0	104,9	45,4
55	34,0	42,4	41,1	42,8	48,9	43,4	57,4	44,1	66,6	44,5	76,4	45,0	86,9	45,3	98,1	45,9	110,0	46,3
60	35,5	43,1	42,9	43,5	51,1	44,1	59,9	44,8	69,5	45,3	79,8	45,7	90,8	46,0	102,5	46,6	114,9	47,1

The performance data were obtained under ideal testing conditions and are the base for the mathematical model. Performance may be adversely affected by wind and other factors. Pressure refers to pressure at nozzle. Performance data regarding flow and throw in relation to installation height and deflector type shown in the tables, originate from the mathematical model used in the Komet Pivot Calculator Software.



Performance data / Datos de rendimiento



**komet | Precision Wave (KPW) HEAD-DOWN YELLOW DEFLECTOR**  
**CABEZA ABAJO DEFLECTOR AMARILLO**

Operating Parameters / Parámetros operativos			Installation / Instalación
Nozzle range / Gama boquillas (1/128")	Pressure range / Gama presiones (psi)	Flow range / Gama caudales (gpm)	Head-Down / Cabeza abajo
52 - 90	15 - 60	17.7 - 114.9	

Pressure / Presión	Throw Radius / Radio alcance R (ft)																	
	Installation Height / Altura instalación <b>H=13ft</b>																	
	Nozzle / Boquilla 52 1/128"		Nozzle / Boquilla 56 1/128"		Nozzle / Boquilla 60 1/128"		Nozzle / Boquilla 65 1/128"		Nozzle / Boquilla 70 1/128"		Nozzle / Boquilla 75 1/128"		Nozzle / Boquilla 80 1/128"		Nozzle / Boquilla 85 1/128"		Nozzle / Boquilla 90 1/128"	
psi	Flow Caudal (gpm)	Radius Radio (ft)	Flow Caudal (gpm)	Radius Radio (ft)	Flow Caudal (gpm)	Radius Radio (ft)	Flow Caudal (gpm)	Radius Radio (ft)	Flow Caudal (gpm)	Radius Radio (ft)	Flow Caudal (gpm)	Radius Radio (ft)	Flow Caudal (gpm)	Radius Radio (ft)	Flow Caudal (gpm)	Radius Radio (ft)	Flow Caudal (gpm)	Radius Radio (ft)
15	17,7	33,7	21,5	34,5	25,5	35,4	30,0	36,0	34,8	36,7	39,9	37,4	45,4	38,0	51,2	38,5	57,5	39,0
20	20,5	35,6	24,8	36,7	29,5	37,5	34,6	38,3	40,1	39,0	46,1	39,6	52,4	40,3	59,2	40,9	66,3	41,4
25	22,9	36,9	27,7	38,1	33,0	39,0	38,7	39,8	44,9	40,5	51,5	41,1	58,6	41,8	66,2	42,5	74,2	43,0
30	25,1	38,0	30,3	39,2	36,1	40,2	42,4	41,0	49,2	41,7	56,4	42,3	64,2	43,0	72,5	43,8	81,3	44,4
35	27,1	39,0	32,8	40,2	39,0	41,2	45,8	42,0	53,1	42,7	60,9	43,4	69,3	44,1	78,3	44,8	87,8	45,5
40	29,0	39,8	35,0	41,0	41,7	42,1	48,9	42,8	56,8	43,5	65,2	44,3	74,1	45,0	83,7	45,7	93,8	46,4
45	30,7	40,6	37,2	41,7	44,2	42,9	51,9	43,6	60,2	44,3	69,1	45,1	78,6	45,8	88,8	46,5	99,5	47,2
50	32,4	41,2	39,2	42,4	46,6	43,5	54,7	44,3	63,5	44,9	72,8	45,8	82,9	46,5	93,6	47,2	104,9	47,9
55	34,0	41,9	41,1	43,0	48,9	44,1	57,4	44,9	66,6	45,6	76,4	46,5	86,9	47,2	98,1	47,8	110,0	48,5
60	35,5	42,4	42,9	43,5	51,1	44,7	59,9	45,5	69,5	46,2	79,8	47,1	90,8	47,8	102,5	48,4	114,9	49,0

Pressure / Presión	Throw Radius / Radio alcance R (ft)																	
	Installation Height / Altura instalación <b>H=6ft</b>																	
	Nozzle / Boquilla 52 1/128"		Nozzle / Boquilla 56 1/128"		Nozzle / Boquilla 60 1/128"		Nozzle / Boquilla 65 1/128"		Nozzle / Boquilla 70 1/128"		Nozzle / Boquilla 75 1/128"		Nozzle / Boquilla 80 1/128"		Nozzle / Boquilla 85 1/128"		Nozzle / Boquilla 90 1/128"	
psi	Flow Caudal (gpm)	Radius Radio (ft)	Flow Caudal (gpm)	Radius Radio (ft)	Flow Caudal (gpm)	Radius Radio (ft)	Flow Caudal (gpm)	Radius Radio (ft)	Flow Caudal (gpm)	Radius Radio (ft)	Flow Caudal (gpm)	Radius Radio (ft)	Flow Caudal (gpm)	Radius Radio (ft)	Flow Caudal (gpm)	Radius Radio (ft)	Flow Caudal (gpm)	Radius Radio (ft)
15	17,7	29,8	21,5	30,8	25,5	31,3	30,0	32,0	34,8	32,7	39,9	33,2	45,4	33,4	51,2	33,8	57,5	34,2
20	20,5	31,9	24,8	33,0	29,5	33,8	34,6	34,3	40,1	34,9	46,1	35,4	52,4	35,7	59,2	36,3	66,3	36,7
25	22,9	33,6	27,7	34,7	33,0	35,6	38,7	36,2	44,9	36,8	51,5	37,2	58,6	37,7	66,2	38,2	74,2	38,6
30	25,1	35,0	30,3	36,2	36,1	37,1	42,4	37,7	49,2	38,4	56,4	38,8	64,2	39,3	72,5	39,8	81,3	40,3
35	27,1	36,3	32,8	37,4	39,0	38,3	45,8	39,1	53,1	39,7	60,9	40,2	69,3	40,7	78,3	41,2	87,8	41,7
40	29,0	37,4	35,0	38,5	41,7	39,4	48,9	40,3	56,8	40,9	65,2	41,4	74,1	41,9	83,7	42,4	93,8	43,0
45	30,7	38,4	37,2	39,5	44,2	40,4	51,9	41,3	60,2	42,0	69,1	42,5	78,6	43,0	88,8	43,5	99,5	44,0
50	32,4	39,2	39,2	40,4	46,6	41,3	54,7	42,3	63,5	42,9	72,8	43,5	82,9	43,9	93,6	44,5	104,9	45,0
55	34,0	40,0	41,1	41,2	48,9	42,1	57,4	43,1	66,6	43,7	76,4	44,4	86,9	44,8	98,1	45,4	110,0	45,8
60	35,5	40,7	42,9	41,8	51,1	42,8	59,9	43,7	69,5	44,4	79,8	45,1	90,8	45,5	102,5	46,1	114,9	46,5

Los datos de rendimiento fueron obtenidos bajo condiciones de ensayo ideales y son base del modelo matemático. El rendimiento puede ser afectado negativamente por el viento y otros factores. La presión se refiere a la presión a la boquilla. Los datos de rendimiento, referentes a caudal y alcance en relación a la altura de instalación y tipo de deflector, que figuran en la tabla, tienen su origen en el modelo matemático, usado en el software del Komet Pivot Calculator.



Highly professional / Altamente profesional



Strict quality control / Estricto control de calidad



Comprehensive product testing / Pruebas exhaustivas de los productos



---

**Quality is not invented.  
Quality is a mindset.**

---

The quality of the product is the essence of our mission. Over the years we have learned that in order to achieve excellence in quality, it is necessary to add the highest levels of technology and innovation to the professionalism of the people involved.

Our manufacturing facility is highly automated. The use of robotic equipment allows us to achieve the highest accuracy and repeatability.

What makes us even more proud is the organizational structure of the company. In many years of development, we have succeeded in creating a perfectly balanced and transparent union between the operating staff and the exploitation of all the potential of our manufacturing equipment. Every detail is cared for. Nothing is left to chance. The result is the capability to offer the market an extraordinarily innovative product with outstanding quality, ensuring unmatched performance and longevity.

---

**Calidad no se inventa.  
Calidad es una mentalidad.**

---

La calidad del producto es la esencia de nuestra misión. A lo largo de los años hemos aprendido, que, para lograr una calidad excelente, es necesario agregar a la profesionalidad de las personas involucradas, los niveles más altos en tecnología e innovación.

Nuestra planta de fabricación es altamente automatizada. El uso de equipos robotizados nos permite alcanzar máxima precisión y repetibilidad. Lo que aún más nos hace estar orgullosos, es la estructura organizativa de la compañía.

En muchos años de desarrollo hemos logrado crear una unión equilibrada y transparente entre el personal operativo y la explotación de todo el potencial de nuestro equipamiento de fabricación. Cada detalle es objeto de cuidado. Nada se deja al azar. El resultado de ello es la capacidad de ofrecer al mercado un producto sumamente innovador, de calidad sobresaliente, asegurando rendimiento y longevidad incomparables.

Automated manufacturing / Fabricación automatizada

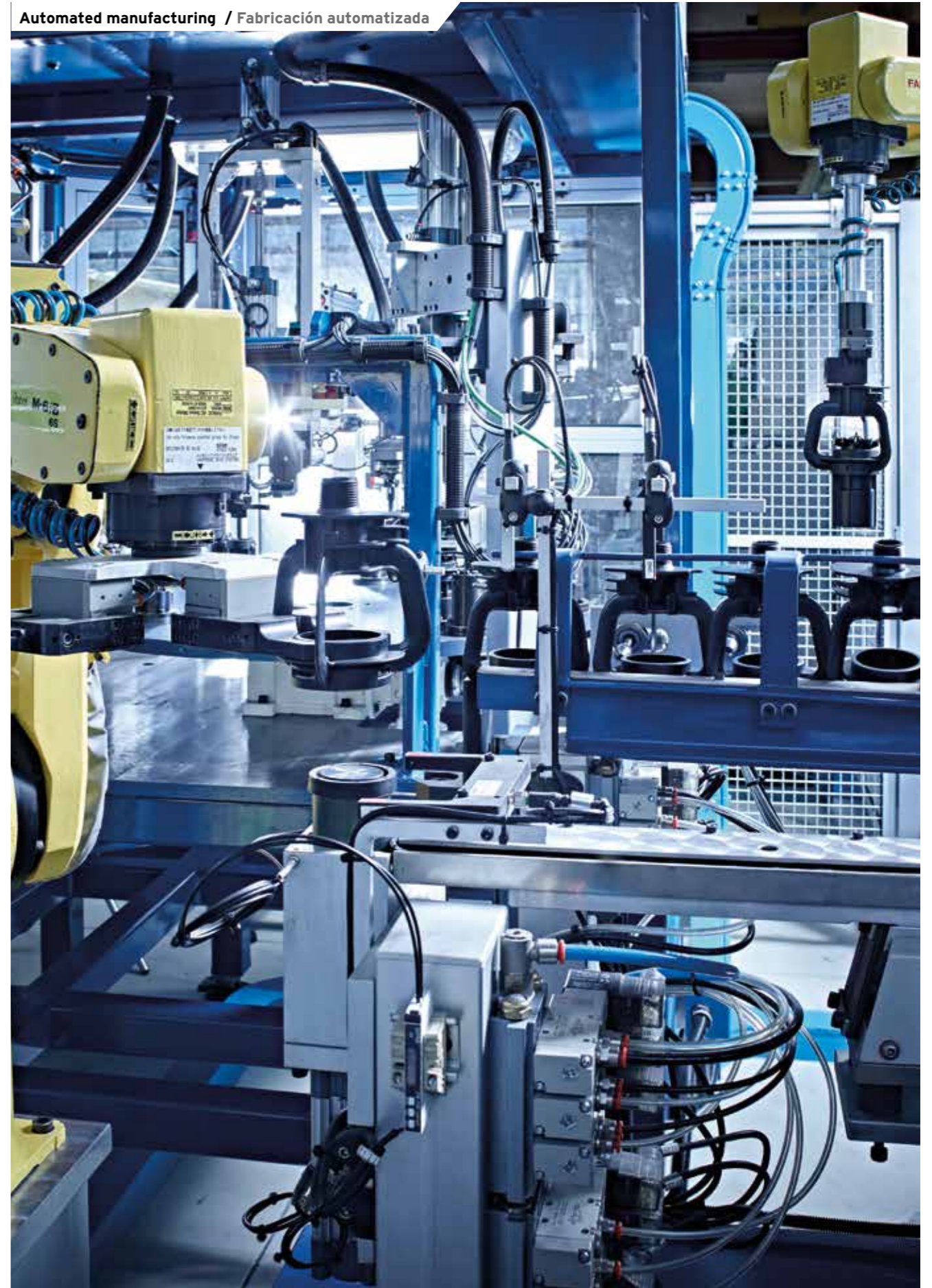



## Limited warranty and disclaimer

The following constitutes the full and complete limited warranty provided by Komet Austria GmbH ("Komet") in relation to its products. This limited warranty is in lieu of any and all other warranties, express or implied, including, but not limited to, any implied warranties of merchantability or fitness for particular purposes. No person or entity is authorized to incur or assume for Komet any other expense, obligation or duty as to products designed, manufactured and/or distributed by Komet.

So long as they are used under normal working conditions and in compliance with the manufacturer's working specifications and maintenance instructions, all products distributed by Komet are warranted to be free of defects in material and workmanship for a period of one year from the date of the product's original shipment. Normal wear and tear arising from operation, damages due to improper or inadequate maintenance and damages due to presence of sand or mud and due to oxidation or any other chemical processes are specifically excluded from this limited

warranty. This limited warranty does not apply to any product that has been altered in any way. Komet undertakes, at its unquestionable judgement, to replace or repair free of charge those parts of the apparatus that proved to be faulty, providing that they are returned shipping charges prepaid. The exclusive and sole remedy with respect to above provisions is expressly limited to the repair or replacement of the part deemed to be faulty. Komet shall not be liable for any crop damages, any direct, consequential or incidental damages to persons or things resulting from any use of Komet's products.

Komet reserves the right, at any time without notice, to alter or modify its products if deemed appropriate or necessary. Illustrations and instructions are for information purposes only and are not binding in any way. Any variations to the above provisions shall be accepted only if defined and confirmed in writing by Komet. In case a legal dispute should arise, the place of jurisdiction is the Court of Lienz/Austria.







**Komet Austria GmbH**

Julius Durst Str. 10  
9900 Lienz/Austria  
Ph. (+43) 4852 71550 500  
Fax. (+43) 4852 71550 550  
komet@kometirrigation.com  
www.kometirrigation.com



Rif. 478 ED, Z24/04 - ...

© Copyright 2024 Komet Austria GmbH

All data, indications and illustrations are only informative and are subject to change at any time without previous notice and without incurring obligation. Todos los datos, las indicaciones y las ilustraciones que aparecen en este folleto se presentan exclusivamente para efectos de información. Los mismos podrán ser variados en cualquier momento sin previo aviso y sin que ello implique responsabilidad alguna para la empresa.